

# HP® ENTERPRISE M552/M553 SERIES TONER CARTRIDGE REMANUFACTURING INSTRUCTIONS



HP ENTERPRISE M552/553 (508A/X) TONER CARTRIDGE

# REMANUFACTURING THE HP ENTERPRISE M552/M553 SERIES TONER CARTRIDGES

By Mike Josiah and the Technical Staff at UniNet

The M552/553 series of multifunction color laser printers are based on a 40-ppm black and color 1200 x 1200 DPI engine, (3600 DPI with RET). The cartridges are an all-in-one type cartridge that consists of the toner supply, drum, and waste chamber.

The basic physical style of this cartridge is similar to others but there are some distinct differences in how the cartridge is built as well as how it works. All will be covered in the instructions.

One major change is in the chip technology. These new cartridges use a technology HP calls CAT which stands for Cartridge Authentication Technology. This feature comes off by default, but if turned on, the user can specify only new genuine HP cartridges can be used. If on, and a remanufactured cartridge with a new aftermarket chip is installed, the printer will not work. It must be turned off. If not, an "Unauthorized Cartridge" message will display.

This system also has an anti-theft feature, which allows the user to lock a set of cartridges to a specific printer. According to HP this helps prevent theft. Once locked if a cartridge is moved to another machine a "Protected cartridge" message will display. This feature is also off by default on new machines.

## PRINTERS BASED ON THE M553 ENGINE

HP Color LaserJet Enterprise M552n  
 HP Color LaserJet Enterprise M552dn  
 HP Color LaserJet Enterprise M552x  
 HP Color LaserJet Enterprise M553n  
 HP Color LaserJet Enterprise M553dn  
 HP Color LaserJet Enterprise M553x

## CARTRIDGES USED IN THE M553 ENGINE

<b>CF360A (Black)</b>	<b>508A</b>	<b>6,000 pages</b>	<b>USD\$150.99 List*</b>
<b>CF360X (Black - High Yield)</b>	<b>508X</b>	<b>12,500 pages</b>	<b>USD\$291.99 List*</b>
<b>CF361A (Cyan)</b>	<b>508A</b>	<b>5,000 pages</b>	<b>USD\$188.99 List*</b>
<b>CF361X (Cyan)</b>	<b>508X</b>	<b>9,500 pages</b>	<b>USD\$291.99 List*</b>
<b>CF362A (Yellow)</b>	<b>508A</b>	<b>5,000 pages</b>	<b>USD\$188.99 List*</b>
<b>CF362X (Yellow)</b>	<b>508X</b>	<b>9,500 pages</b>	<b>USD\$291.99 List*</b>
<b>CF363A (Magenta)</b>	<b>508A</b>	<b>5,000 pages</b>	<b>USD\$188.99 List*</b>
<b>CF363X (Magenta)</b>	<b>508X</b>	<b>9,500 pages</b>	<b>USD\$291.99 List*</b>
<b>B5S62A (Toner Collection Unit)</b>			<b>USD\$ 17.99 List*</b>

\*Pricing (in U.S. American Dollars) current as of October 2015



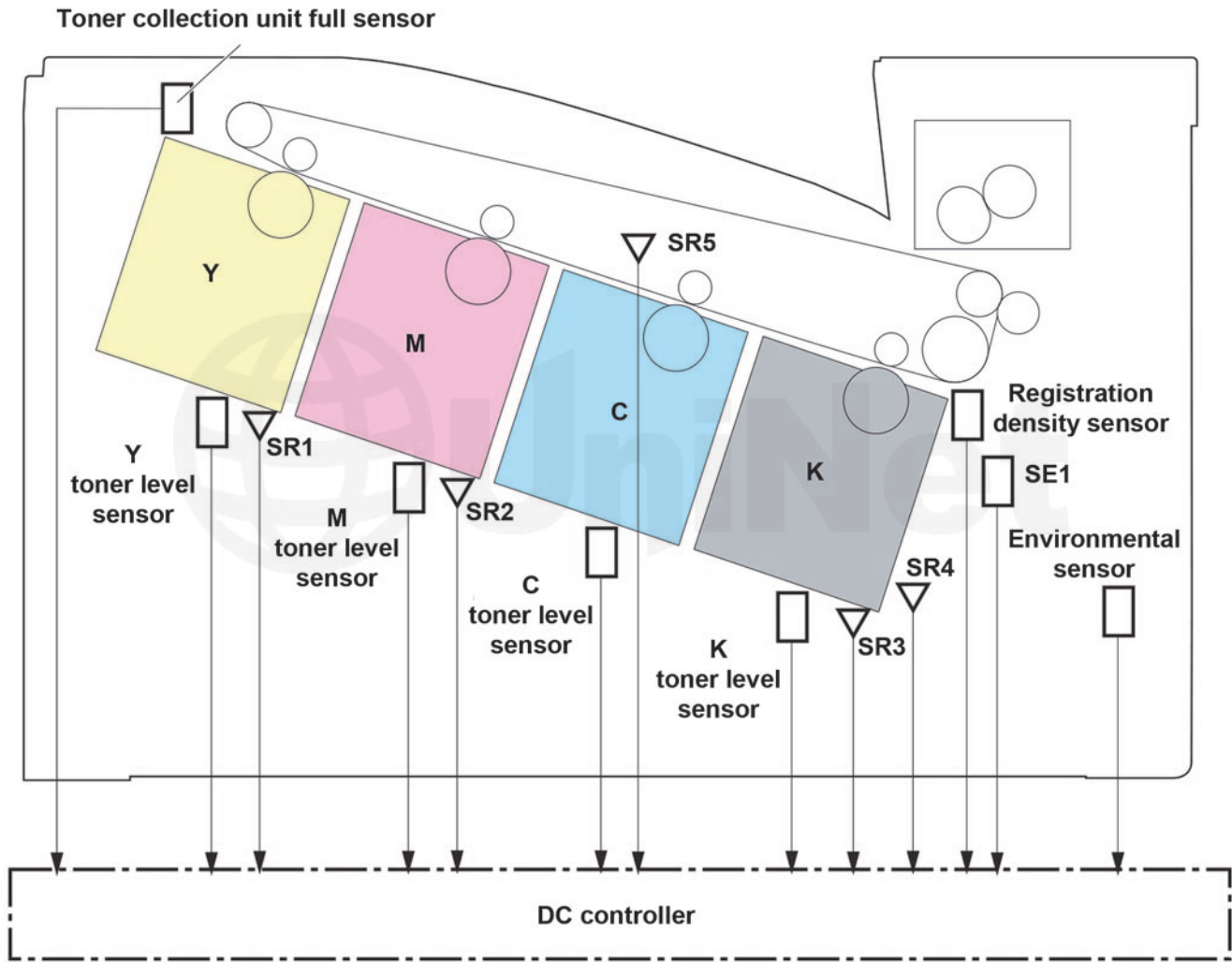

As the Printing Theory has changed a bit we are covering it here.

The color toner cartridge printing process happens in a series of stages or steps. For the purpose of this article, we will call them stages.

Shown is the basic layout of the cartridges and how they relate to one-another and the printer. Note that the laser units are on the bottom, the cartridges are at an angle, and the ITB is on top.

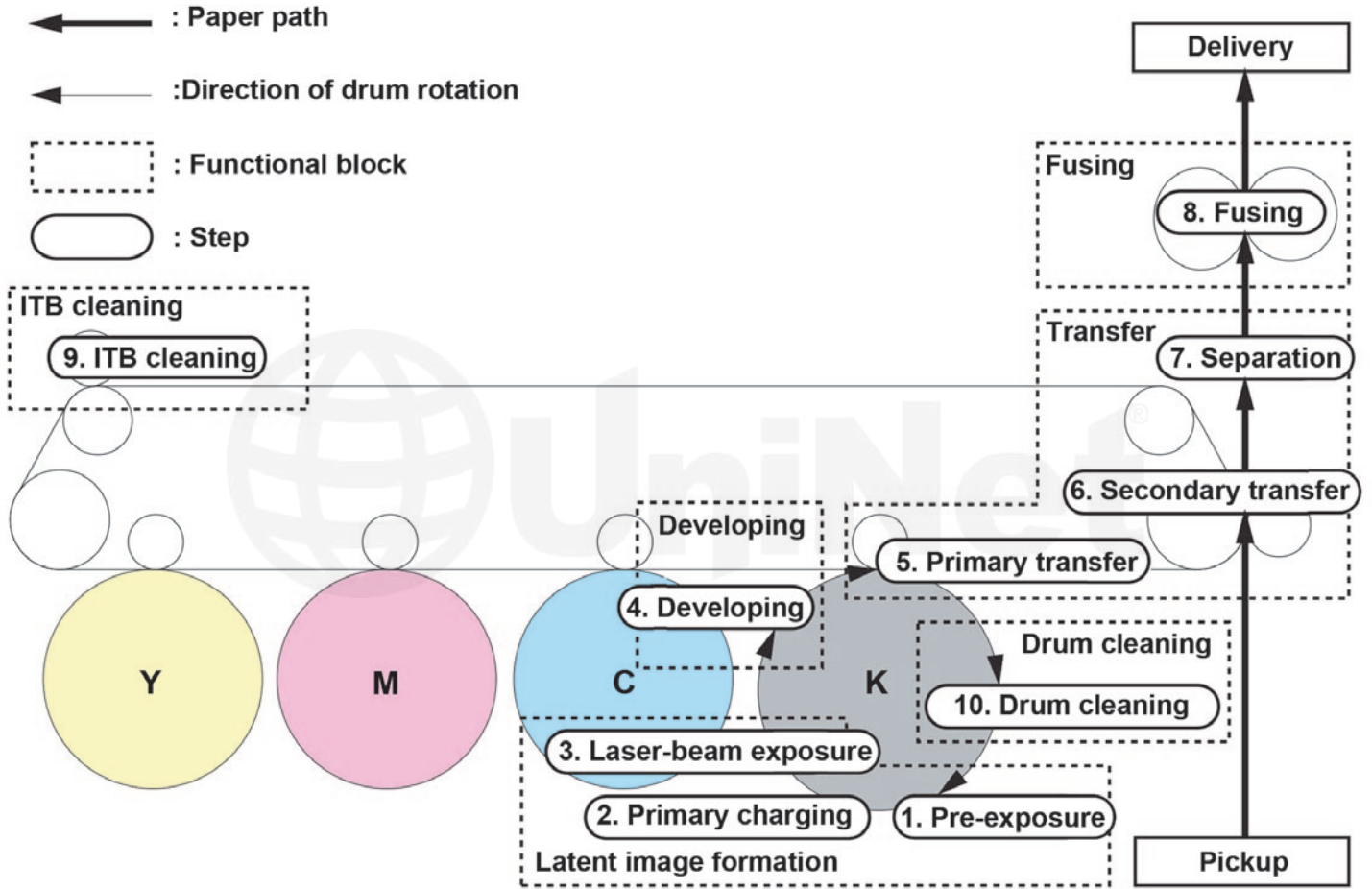

Shown is the complete image formation process.

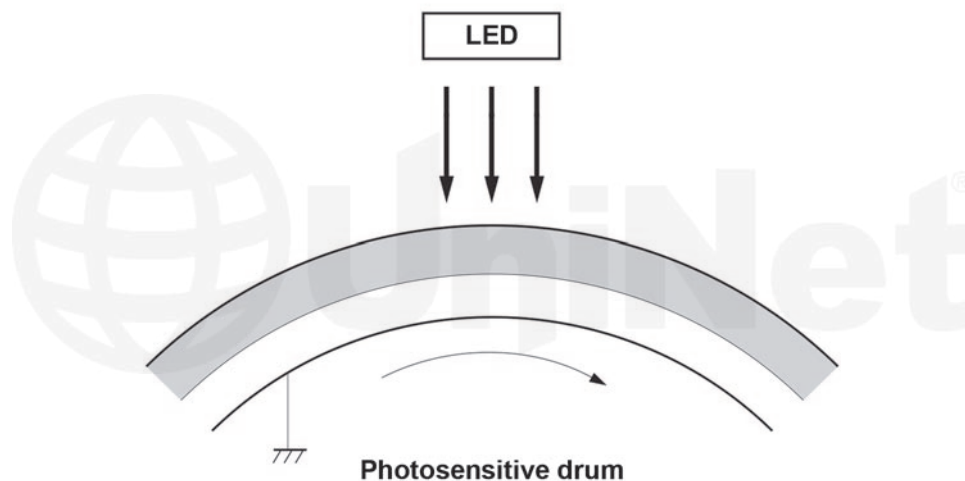

In the **first** stage, light from the pre-exposure LED strikes the drum to remove any residual charges from the drums surface. This LED erases all residual images and charges. In older the machines the PCR ran a DC and an AC voltage. The AC was to help erase any residual voltages. In newer engines the PCR charges the drum only and the LED erases. So if you're getting ghosting and/or backgrounding it's not the PCR but most likely is a dirty LED lamp.

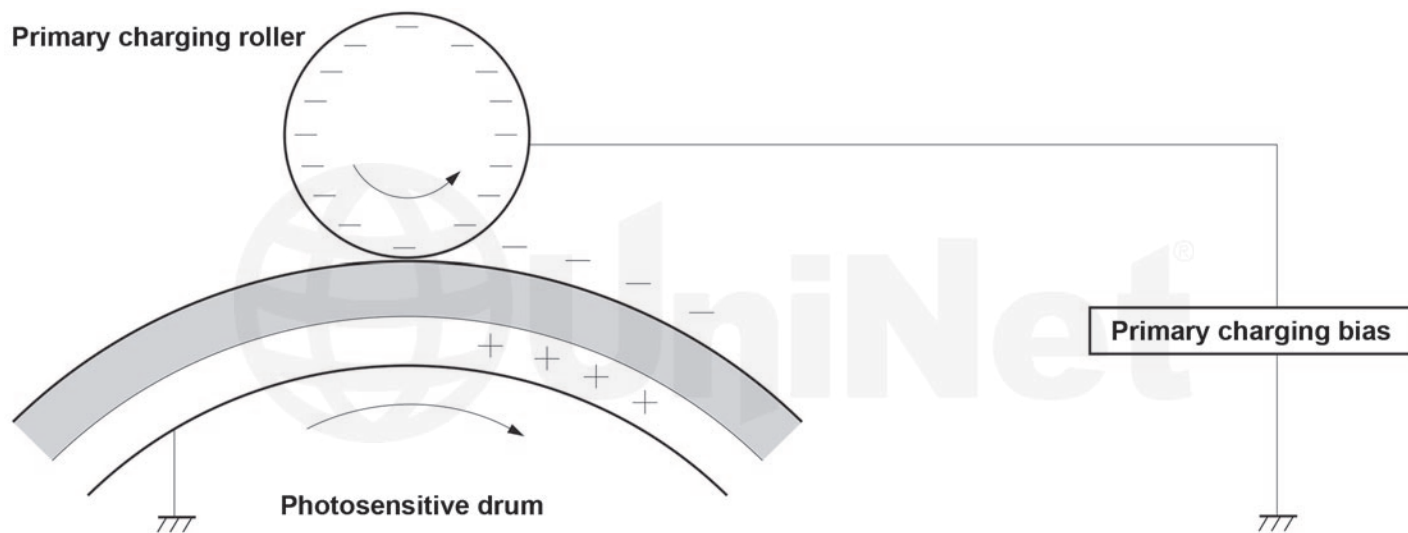

Then the Primary Charge Roller (PCR) places a uniform negative DC voltage on the OPC drum surface.

The amount of the negative DC voltage placed on the drum is controlled by the printer's intensity setting.

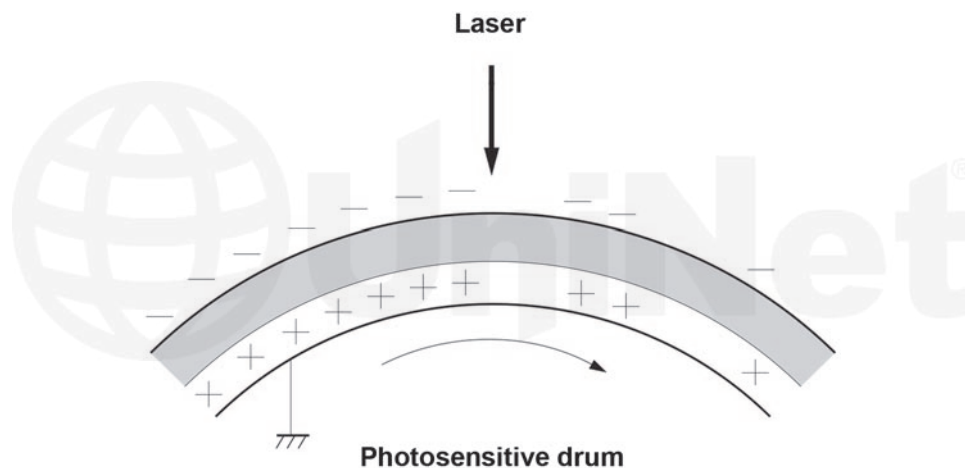

In the **second** stage, a laser beam is fired onto a rotating mirror (called the scanner). As the mirror rotates, the beams are reflected into a set of focusing lenses. The beams then strike the drums surface, reducing the negative charge and leaving a latent electrostatic image on the drum. The areas where the lasers did not strike the drum will retain the higher negative charge.

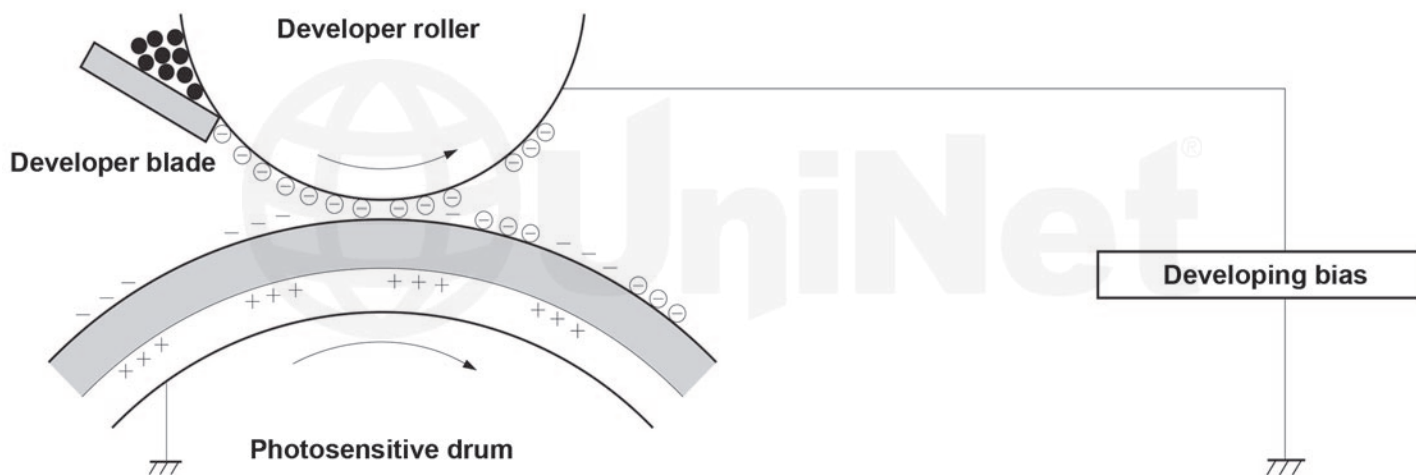

The **third** or **developing** stage is where the toner is developed on the drum by the developing section (or supply chamber), which contains the toner particles. The development stage is actually made up of two steps: toner charging, and the actual development. In the toner charging stage, the toner-stirring blade turns inside the hopper. As it turns, friction causes a negative potential to develop on the toner. In addition, a (foam) feed roller brings the toner to the developer roller and also places a negative charge on the toner. These two charges help ensure a uniform charge on the toner. Once the toner is properly charged, the toner will coat the developer roller. The toner is also held onto and attracted to the developer roller by another negative DC bias voltage. This voltage is controlled by the printer's intensity setting and causes either more or less toner to be attracted by the developer roller. This in turn will either increase or decrease the print density. The amount of toner on the developer roller is controlled by the doctor blade, which uses pressure to keep the amount of toner on the roller constant.

As the laser exposed areas of the OPC drum approach the developer roller, the toner particles are attracted to the drum's surface due to the opposite voltage potentials of the toner, and laser-exposed areas of the OPC drum.



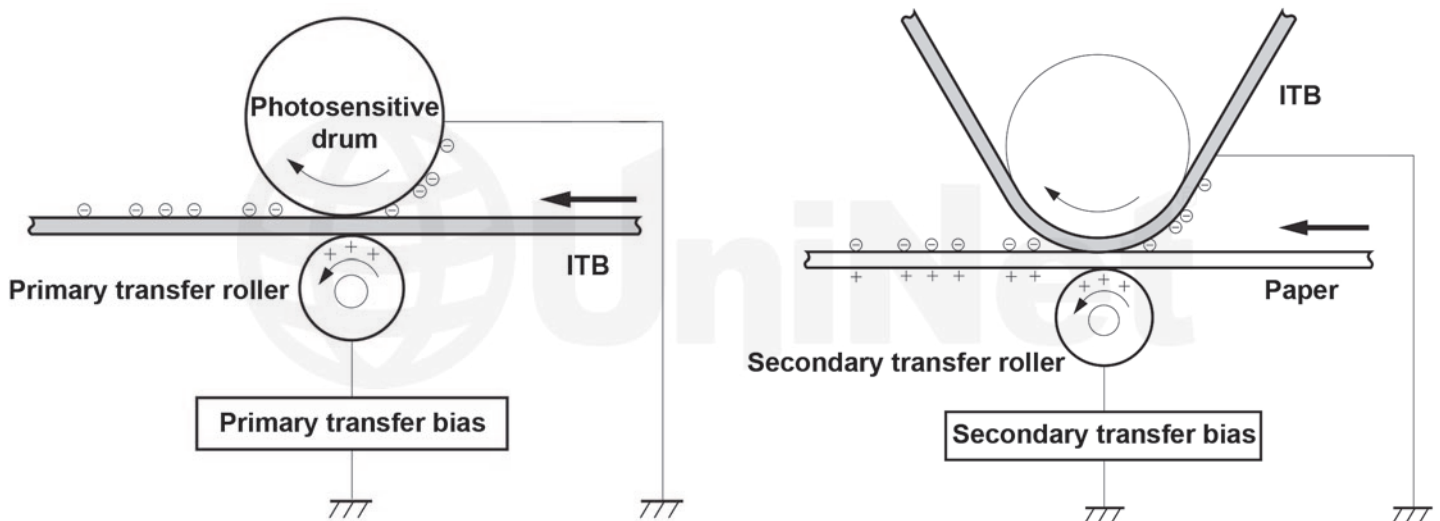

The **fourth** stage is the **transfer** stage. This is where there are some large differences from monochrome printers and also from other color lasers. In the Primary transfer stage the transfer roller, which is located directly opposite each OPC drum, places a positive DC bias charge on the back of the ITB or Image Transfer Belt. Each toner cartridge has a separate transfer charge roller. The image is transferred from the drum directly to the ITB. This process is repeated for each color cartridge in the following order: Yellow, Magenta, Cyan and Black. At the same time, the paper is moving between the Secondary transfer roller and the ITB. As the ITB passes the Secondary transfer roller, the positive charge is picked up, and draws the negatively charged toner off the Belt and onto the paper. Note that this entire process is upside down from most previous HP engines. The ITB and transfer rollers are on top of the OPC drum, not underneath it.

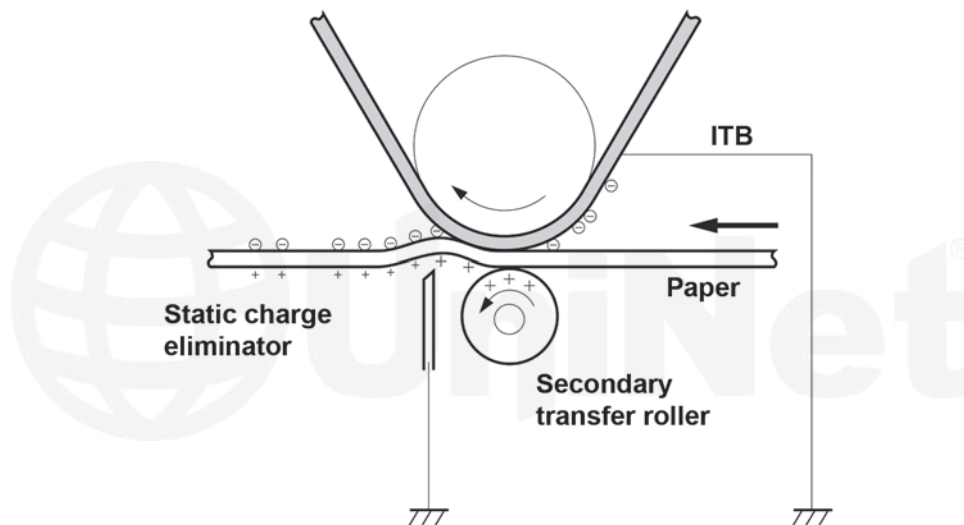

The paper separates from the ITB belt as the belt turns back down to start the process again. The static charge on the back of the paper is decreased with static charge eliminator. This helps stabilize the paper feed, and also prevents toner flares (spots) under low temperature and low humidity conditions.

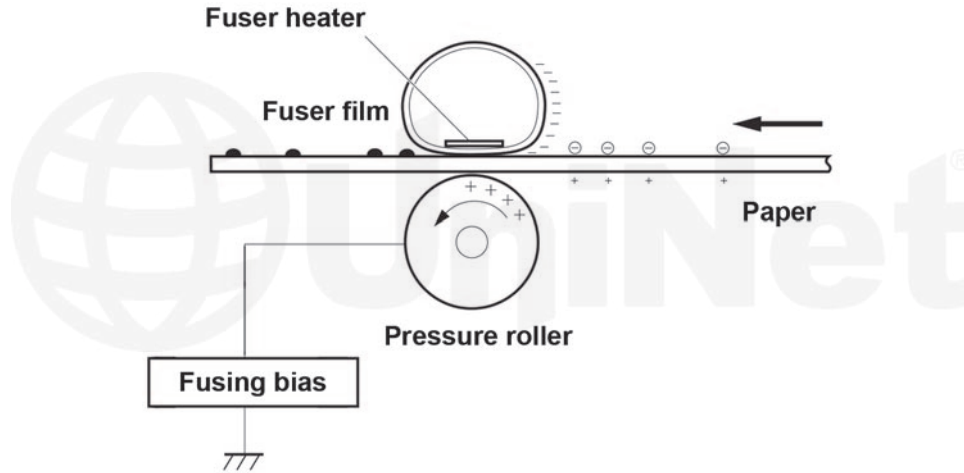

In the **fifth** stage, the image is then fused onto the paper by the fuser assembly. The fuser assembly is comprised of the upper heating assembly and lower pressure roller. The lower pressure roller presses the page up into the upper heating assembly, which then melts the toner into the paper. This heating assembly consists of a flexible sleeve with a ceramic heating coil inside. This type of fuser affords “instant on” fusing with little to no wait time, and low power consumption.

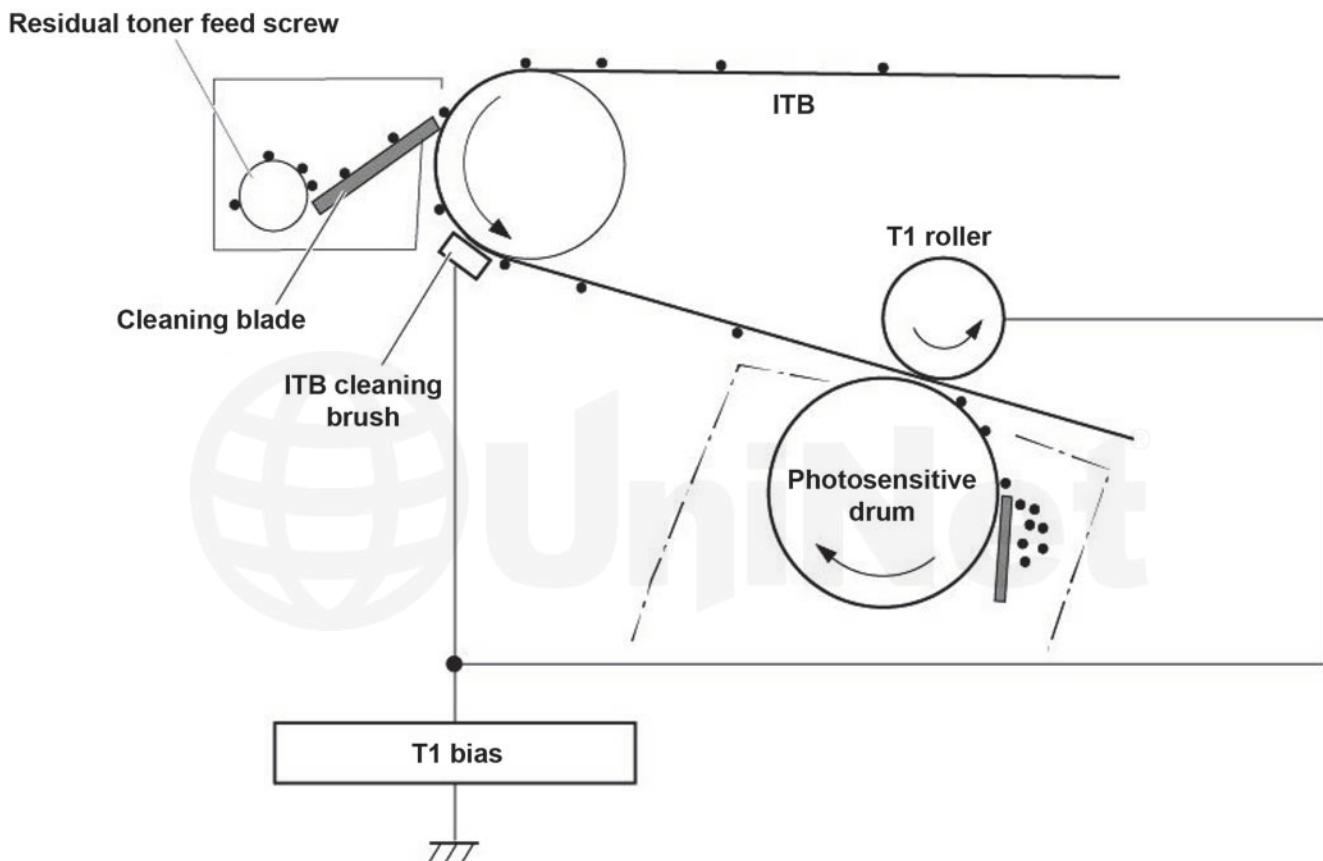

**ITB CLEANING**

The ITB is cleaned by the ITB cleaning blade.

The ITB wiper blade scrapes off the residual toner and an auger moves the toner to the toner collection box.



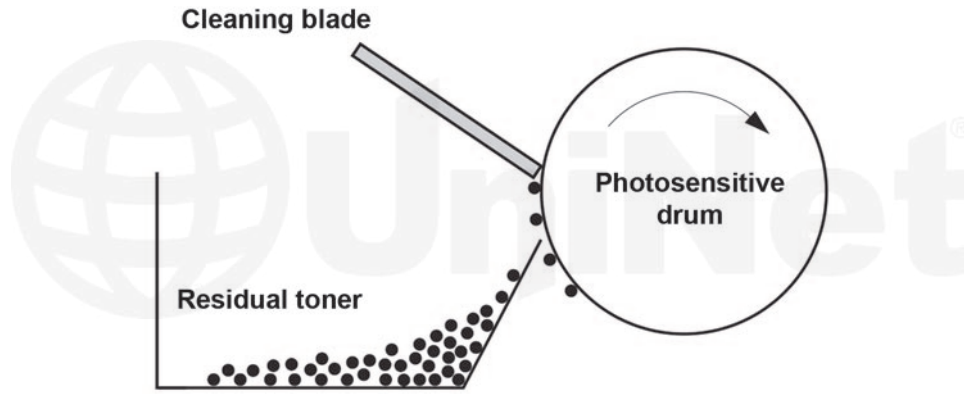

**OPC DRUM CLEANING**

The drum is cleaned after the image is transferred to the paper by the wiper blade. This part is fairly standard; the wiper blade scrapes the toner off the drum, and the recovery blade guides it into the waste chamber.

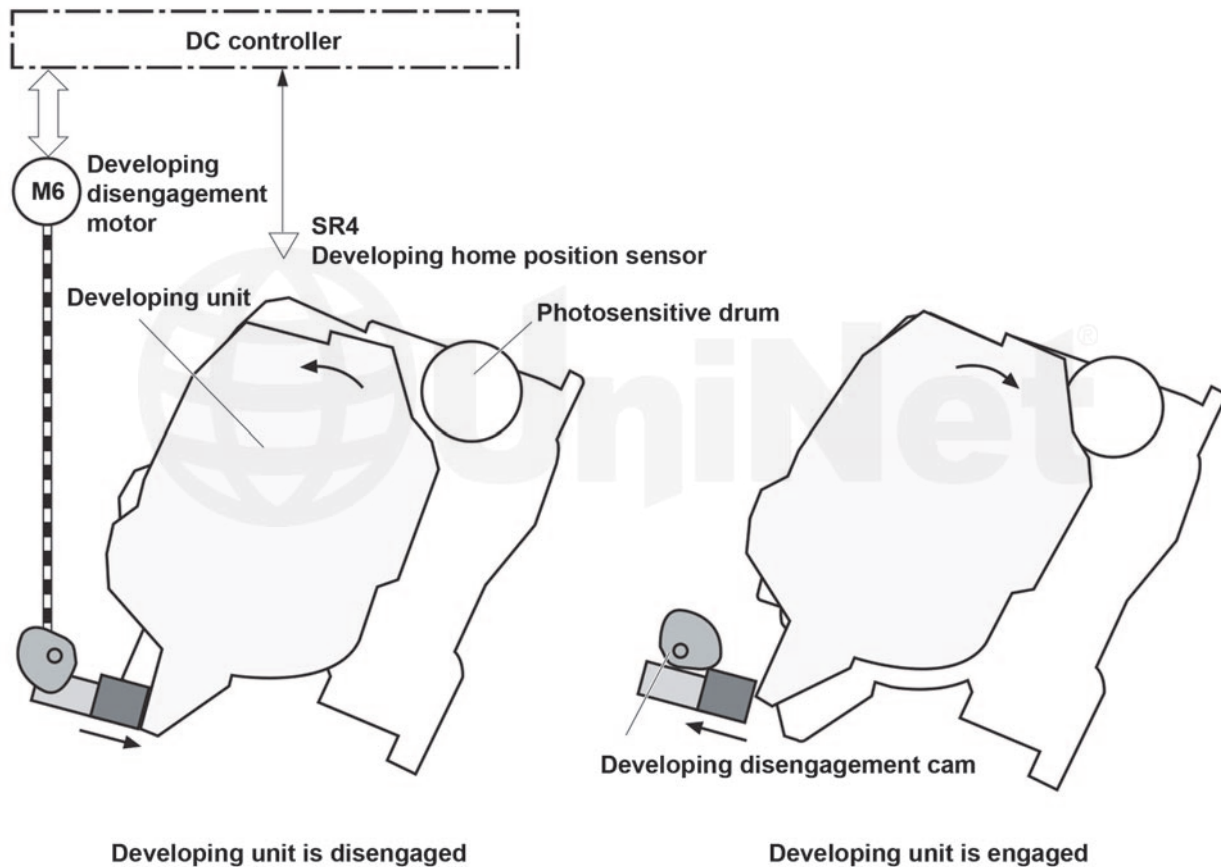

These printers can print in full color, or in black-only modes.

To print in the black-only mode, the printer disengages the developer rollers in the cyan, magenta, and yellow cartridges

This process also takes place with the Primary transfer rollers and the ITB belt.

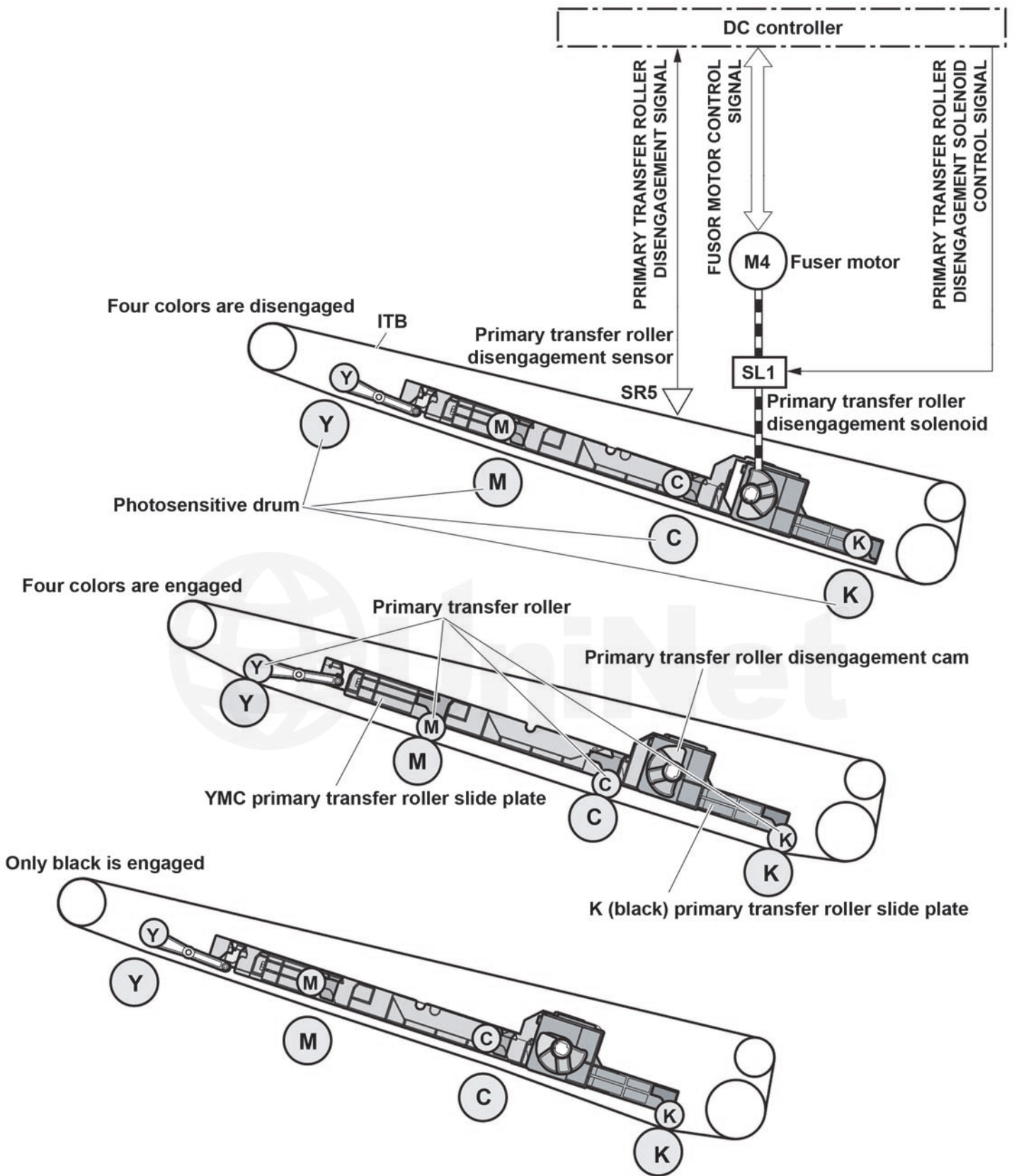

**REQUIRED TOOLS**

1. Toner approved vacuum
2. A small screwdriver (common style)
3. A Phillips head screwdriver
4. Needle nose pliers
5. Spring hook

**REQUIRED SUPPLIES**

1. Toner for use in the HP M553 series
2. New replacement chip
3. New long life drum
4. New wiper blade
5. Drum cover
6. Lint free cloths
7. Conductive grease
8. Isopropyl alcohol
9. Cotton swabs

The pins in these cartridges are stepped. In other words the outside is thicker than the inside. To remove the pins, you must carefully shave the plastic away from the pins. The procedure is described as follows.

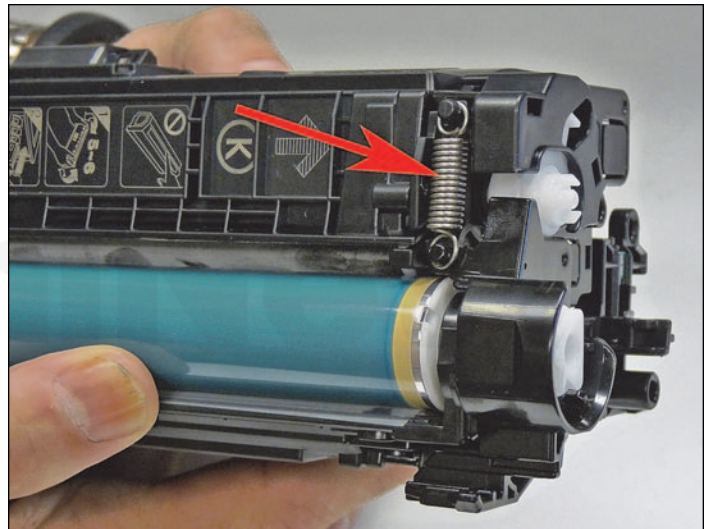
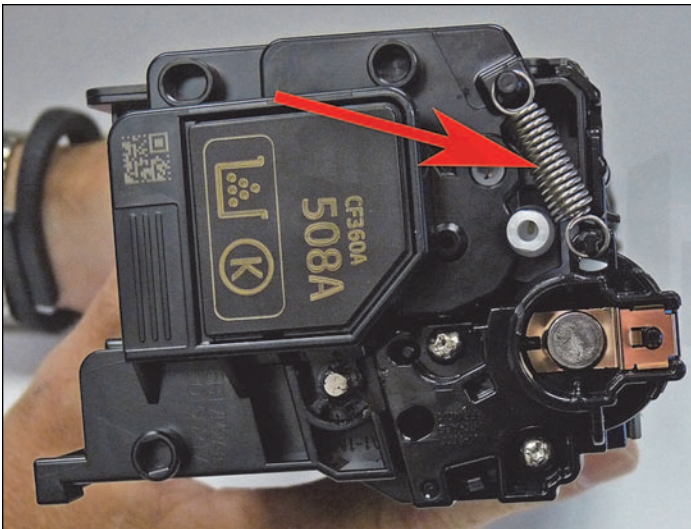

1. Remove the springs from both sides of the cartridge.



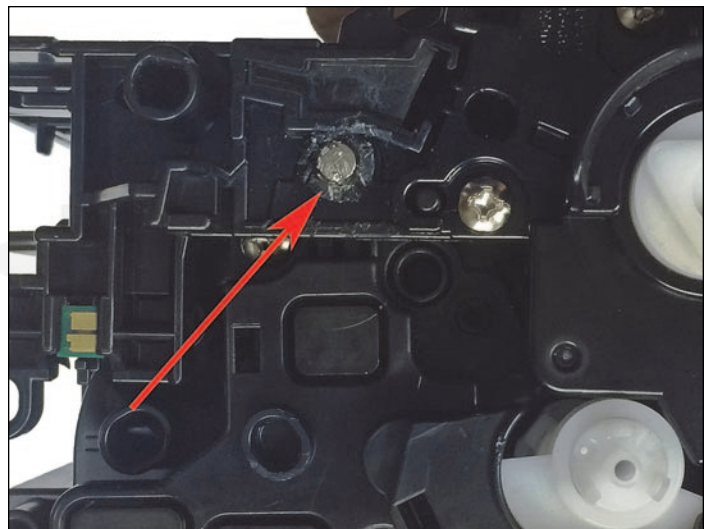
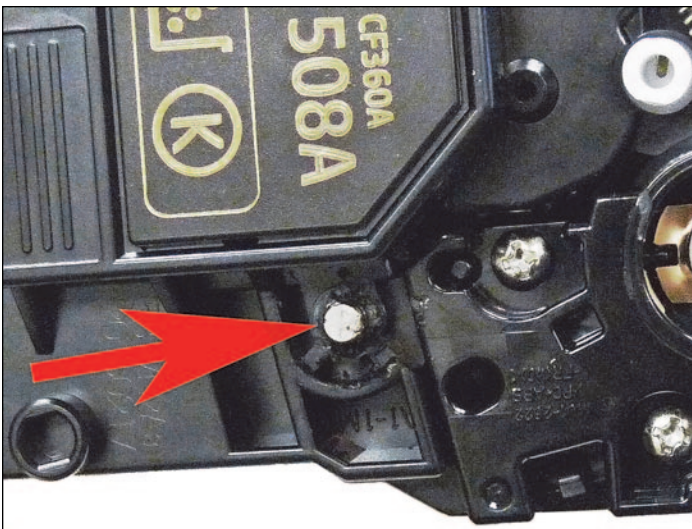
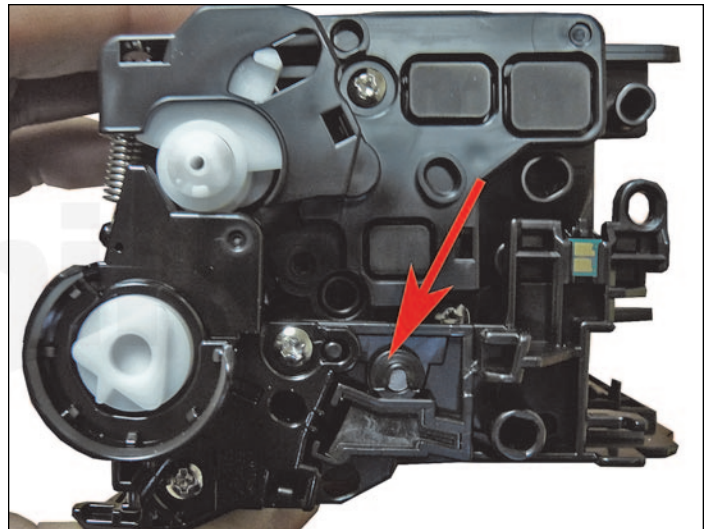

2. With a razor knife, carefully shave the plastic from the heads of the hinge pins on both sides of the cartridge.

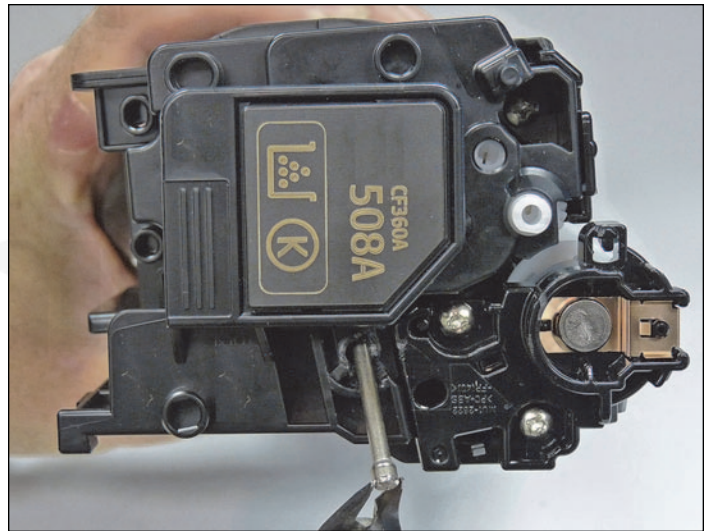
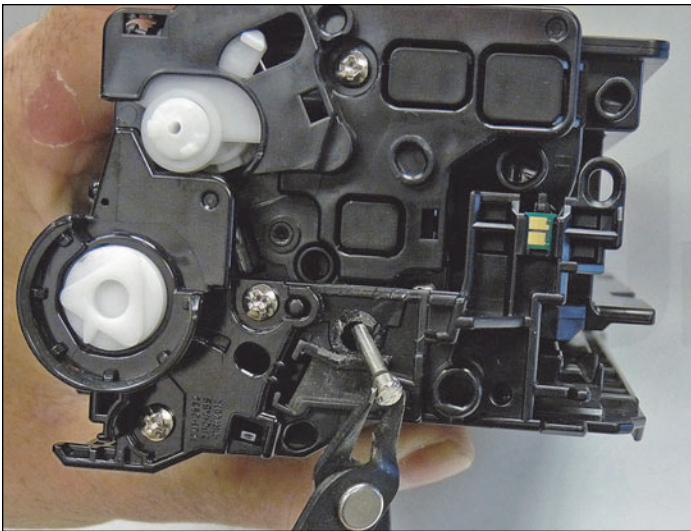

3. Remove the pins with flush cutting wire cutters.

The smaller pin fits on the chip side of the cartridge, the long pin on the label or gear side

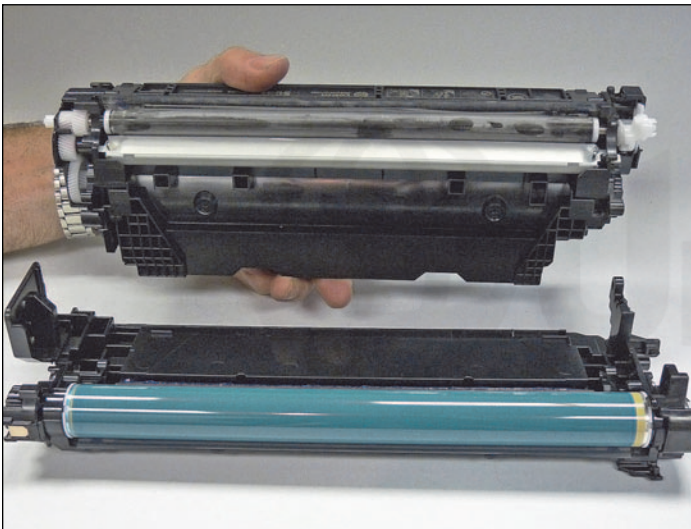

4. Lift the two halves apart.



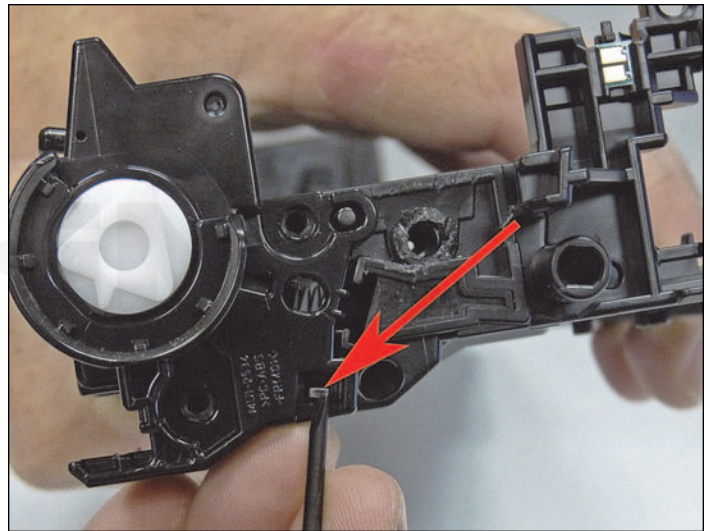
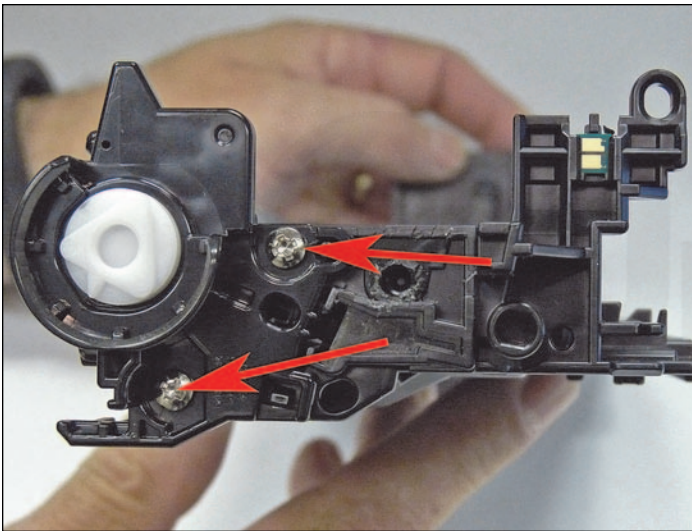

5. On the waste chamber, remove the two screws from the drum gear end cap.

Press in on the tab as shown and remove the end cap.

There is no need to remove the opposite side end cap.

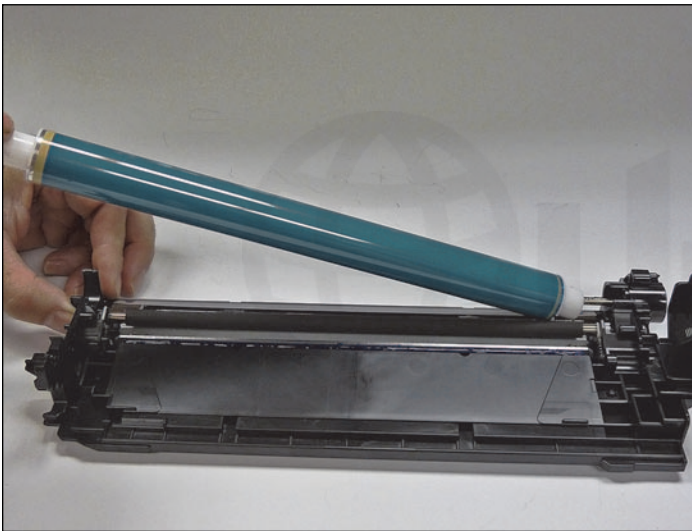

6. Remove the drum.

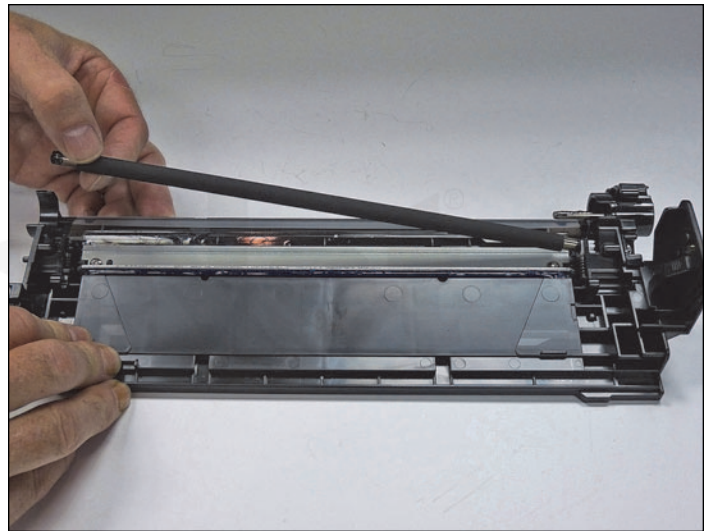

7. Remove the PCR.





8. Remove the two screws from the wiper blade.

Slide the razor knife along the back edge of the blade to release it from the glue.

Remove the wiper blade.

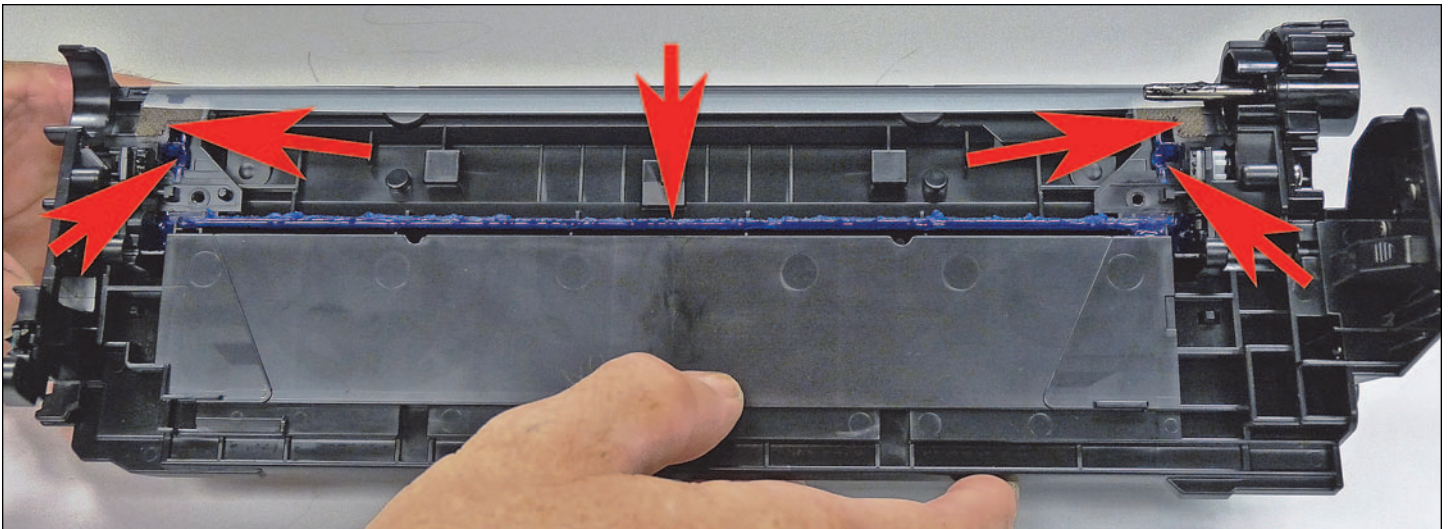

9. Clean out all the waste toner from the chamber. Try not to get any toner on the wiper blade seal if possible.

10. Clean the felt seals on each end of the wiper blade. If the wiper blade glue has toner on it, clean it off with alcohol and a foam swab. If it does not become sticky again, it needs to be removed and a good silicone caulk used to seal the blade off. GE 100% Silicone and Phenoseal are two good brands for this.

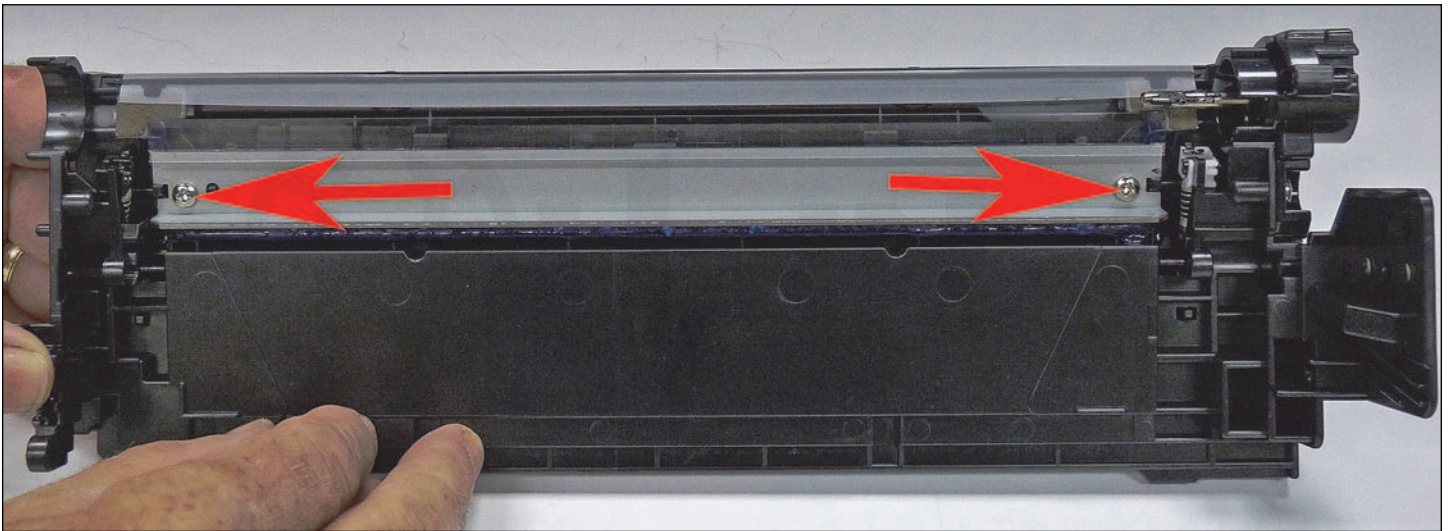

11. Install a new, lubricated wiper blade and two screws.

If you removed the wiper blade glue, seal the back edge of the blade with the silicone now.

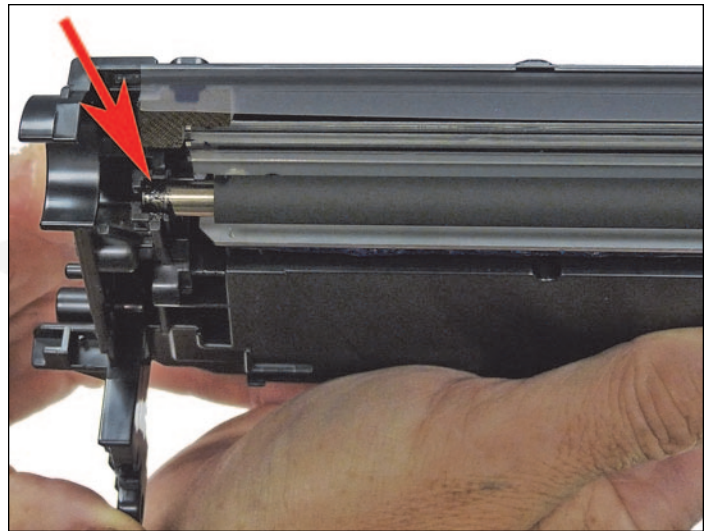
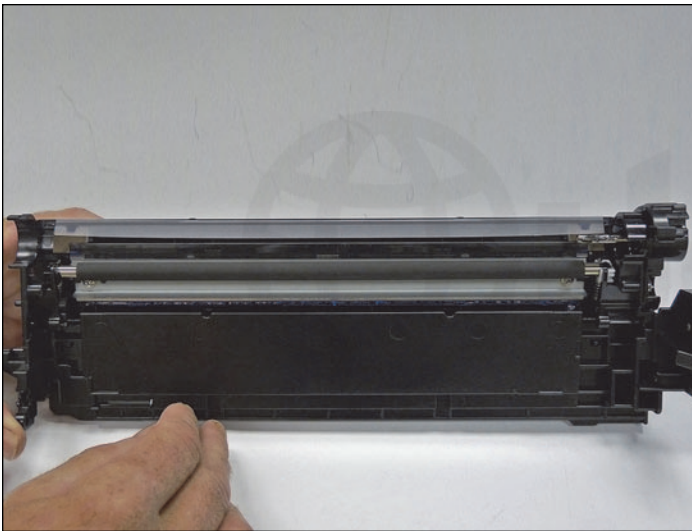

12. Clean the PCR with your preferred cleaner and install in the cartridge. Note there is conductive grease on both sides of the PCR axle. If worn or dirty, clean the axles and holder with alcohol and replace with conductive grease. Replace with the same amount that was there. More is NOT better!



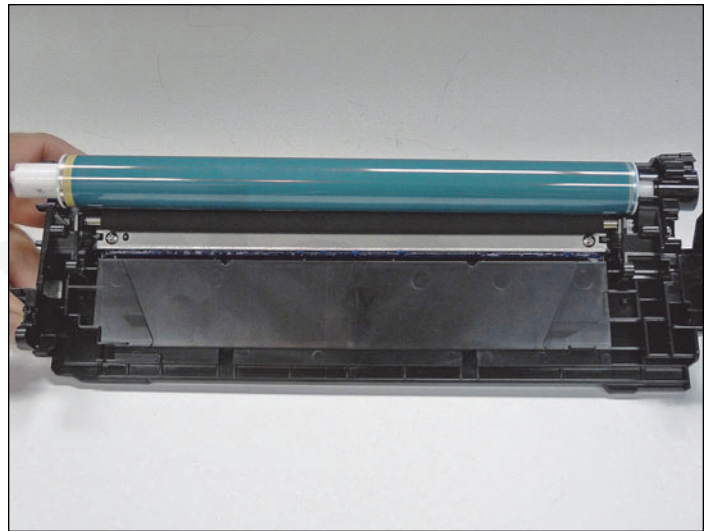
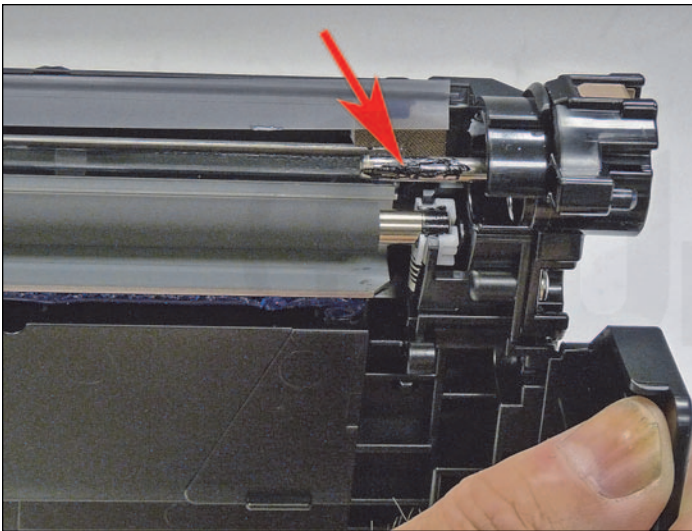

13. Clean and replace the conductive grease on the drum axle.

Install the drum, short hub side onto the long drum ground-pin.

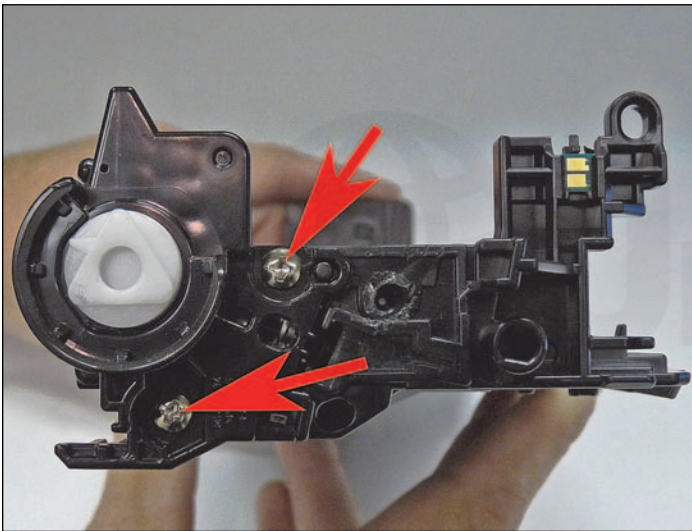

14. Install the end cap and two screws.

15. Place the waste chamber aside.

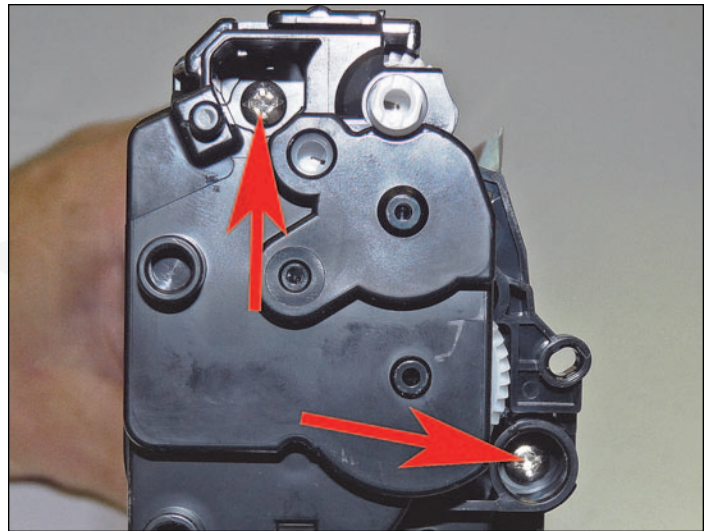

16. On the supply chamber, remove the two screws from the gear side end cap.

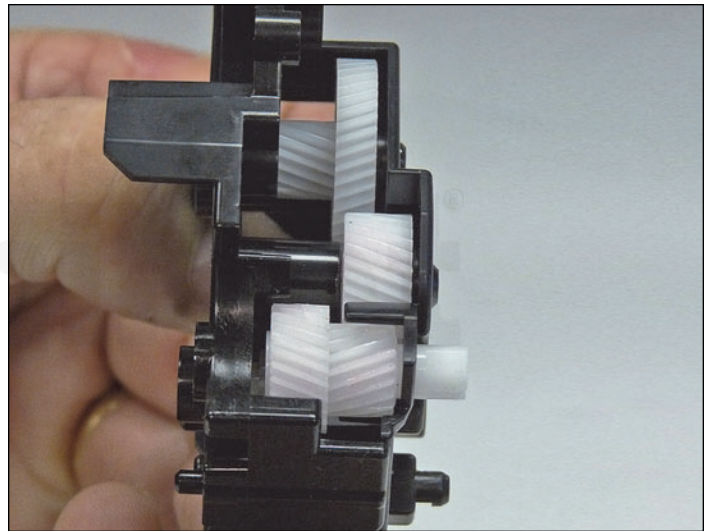
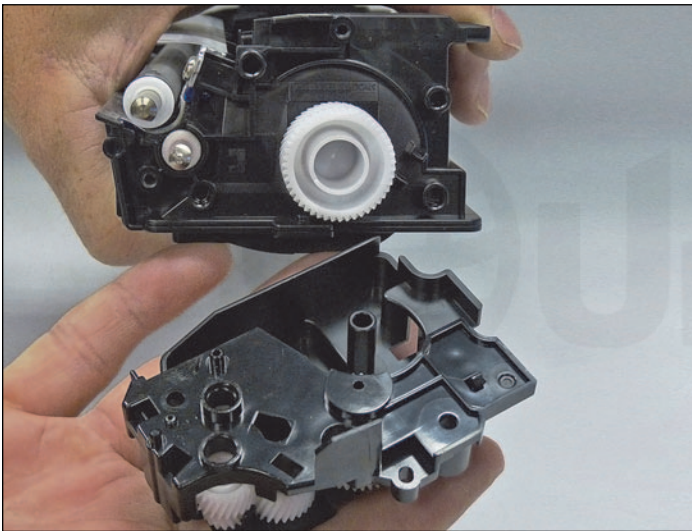

17. Remove the end cap.

Note that almost all the gears stay in the end cap!

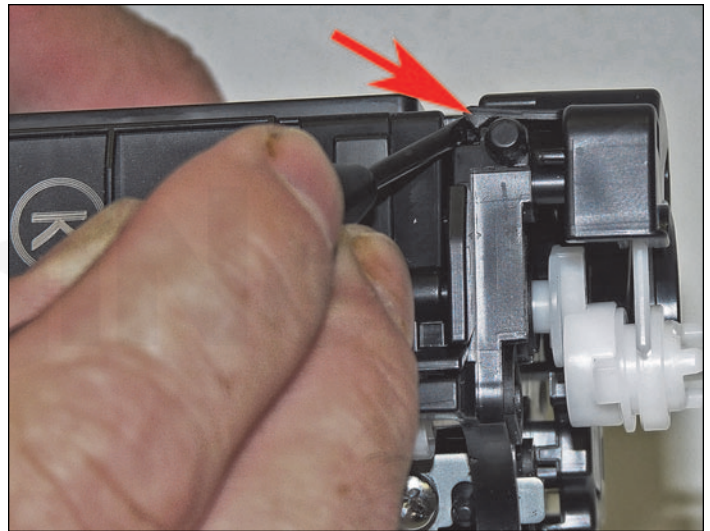
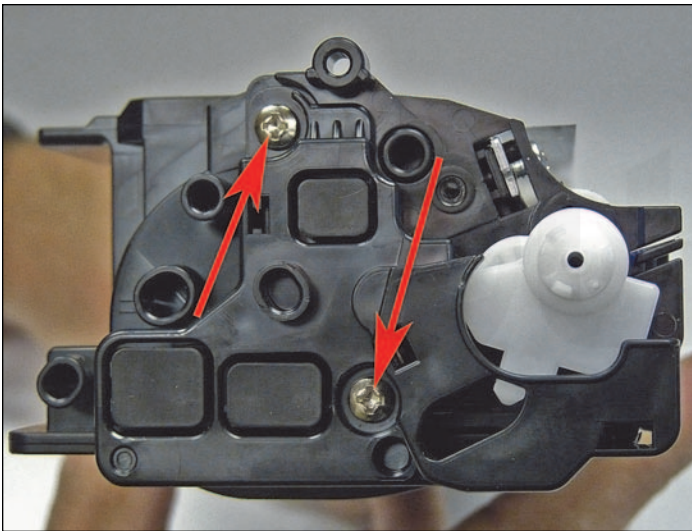

18. On the contact side, remove the two screws, pry out on the tab, and remove the end cap.





19. Remove the three developer roller drive gears.

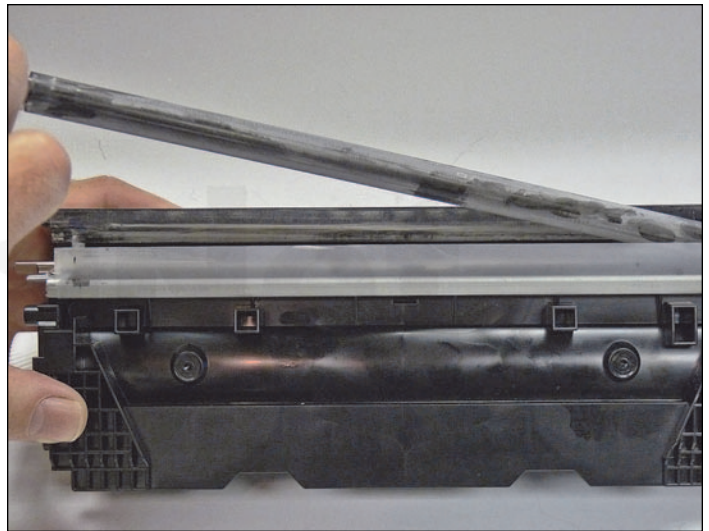

20. Remove the developer roller.



21. Remove the two screws from the doctor blade.

**IMPORTANT:** The right (gear side) screw uses a Left Hand Thread!

Lift the blade up and twist so that it comes free from the cartridge.

Keep the Left Hand threaded screw separate!

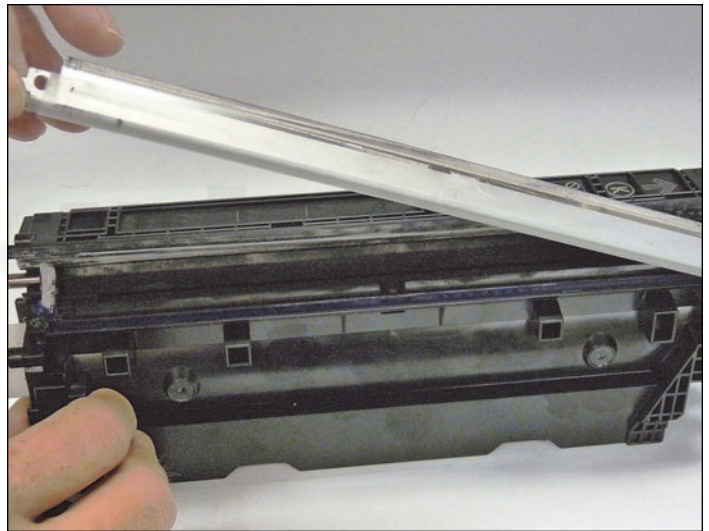

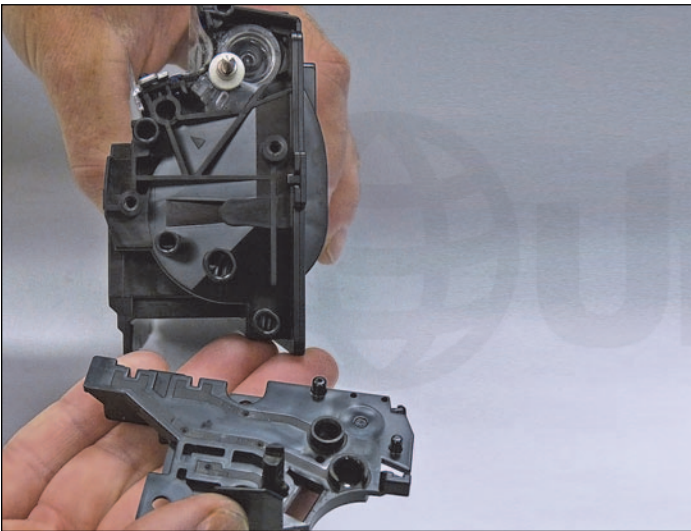

22. Remove the contact side inner end cap.

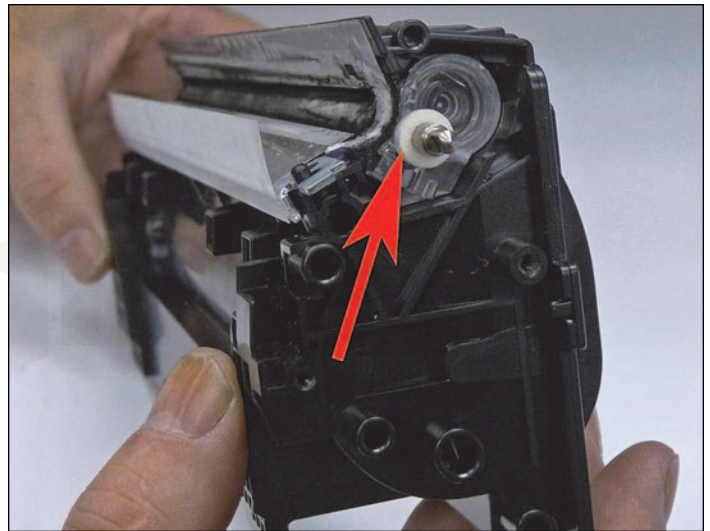

23. Remove the round white felt washers from both sides of the feed roller.

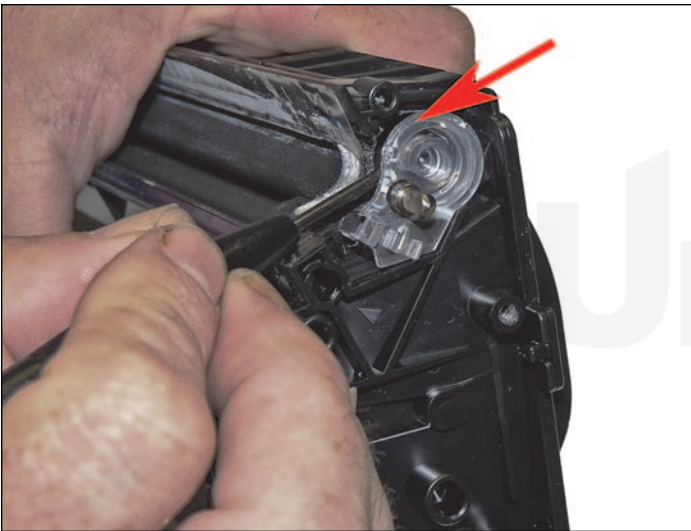

24. Carefully pry around the clear bushing that holds the feed roller in place. The plastic bushing can be removed by carefully prying it up with a small screwdriver from all around the edges. If you choose not to do this, you can melt a small hole in the supply chamber to clean the chamber out.

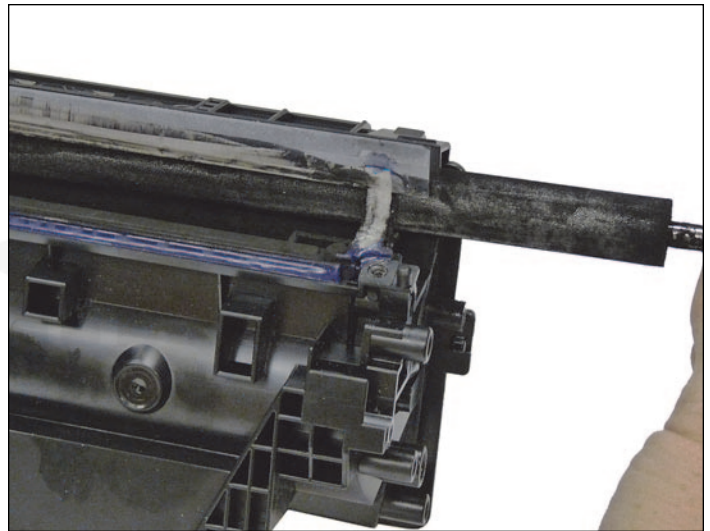

25. Remove the feed roller.





26. These cartridges have a self-removing seal that is not accessible from the outside of the hopper. Shown is a new hopper with and without the seal. To install a seal, it appears the hopper will have to be split. Testing is ongoing for this possibility.



27. Clean out the remaining toner and fill with the correct color of toner for use in the M553 series toner.

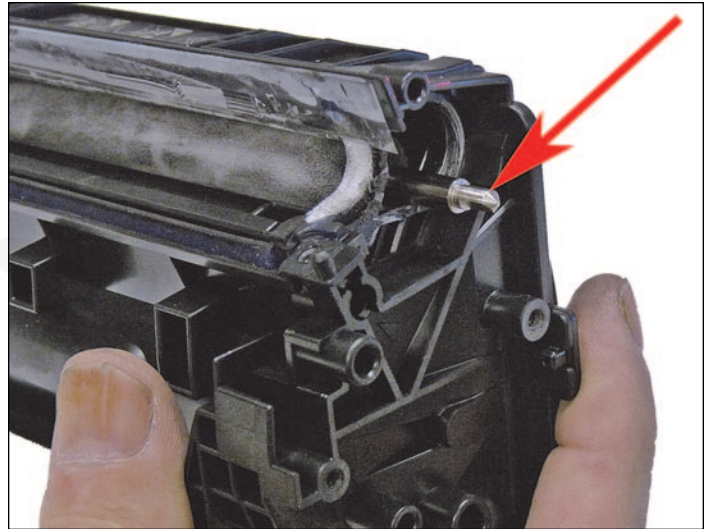

28. Install the feed roller, pointed-end to the open side.

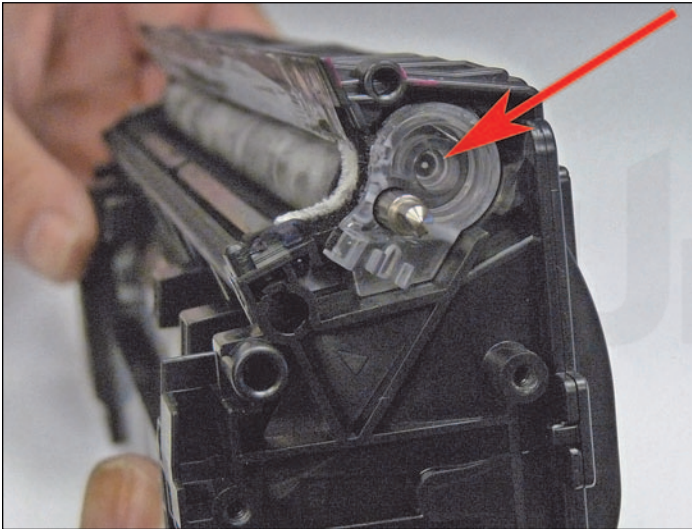

29. Install the clear plastic bushing. Use a very small amount of a silicon sealer to make sure there are no leaks. Be careful to keep the silicon around the outside edges.

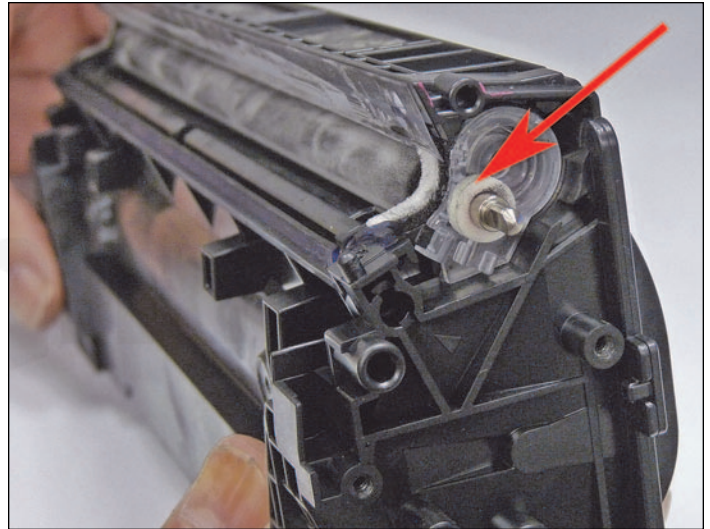

30. Install the feed roller felt washers.



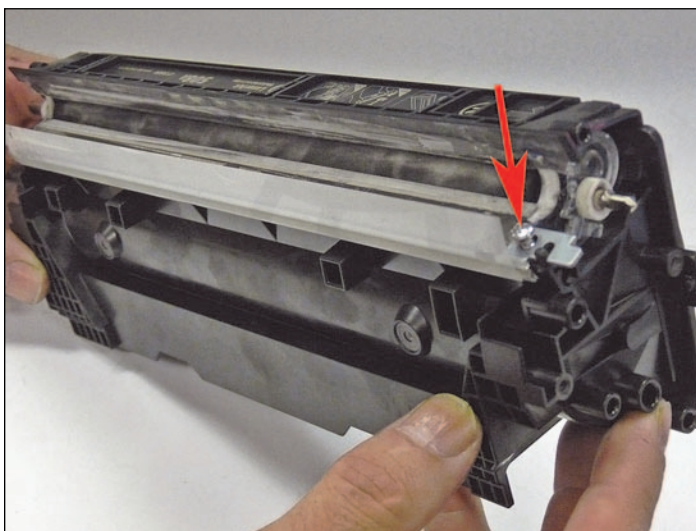

31. Use the appropriate shims to gap the blade and install the doctor blade and two screws. Make sure the sticky seals on either end of the blade seal correctly. If the material is no longer sticky, clean it with alcohol or replace it with a small amount of silicon. Leave the right side “left-hand screw” partially installed.

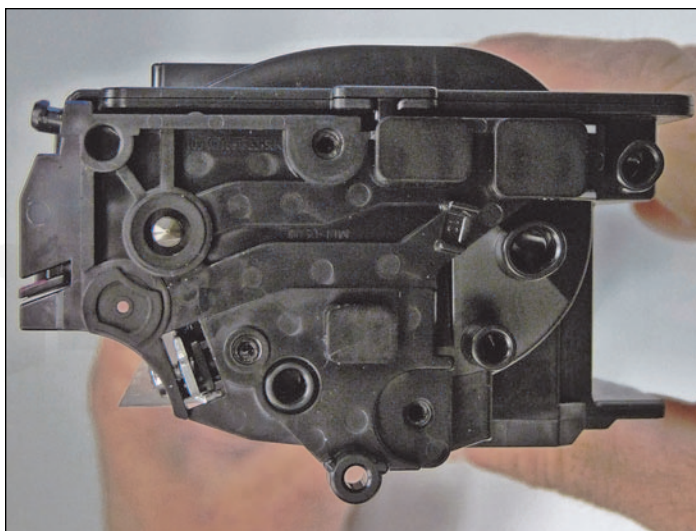

32. Install the inner contact end cap.

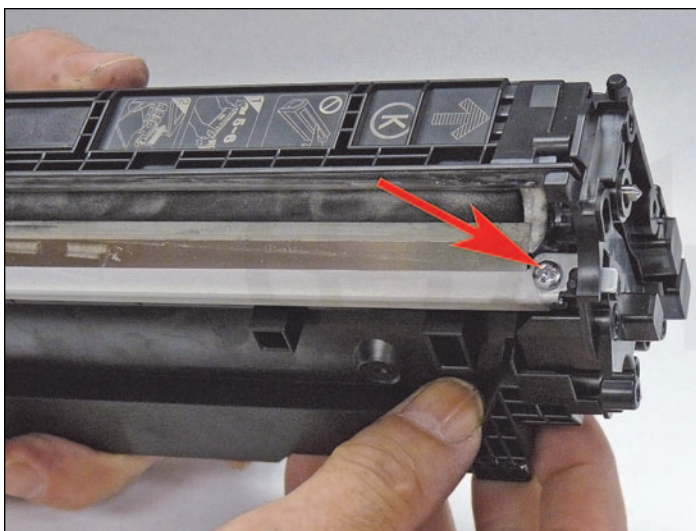

33. Install the left-hand doctor blade screw fully. This screw fits into a post on the inner end cap. The doctor blade is hard to install correctly if the inner end cap is already in place.

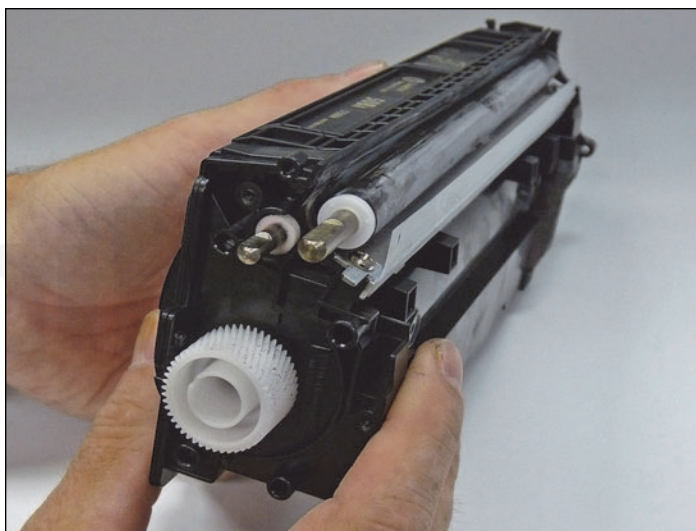

34. Install the cleaned developer roller, keyed-end to the gear side. Do NOT use any chemicals to clean this. A lint free cloth works fine.

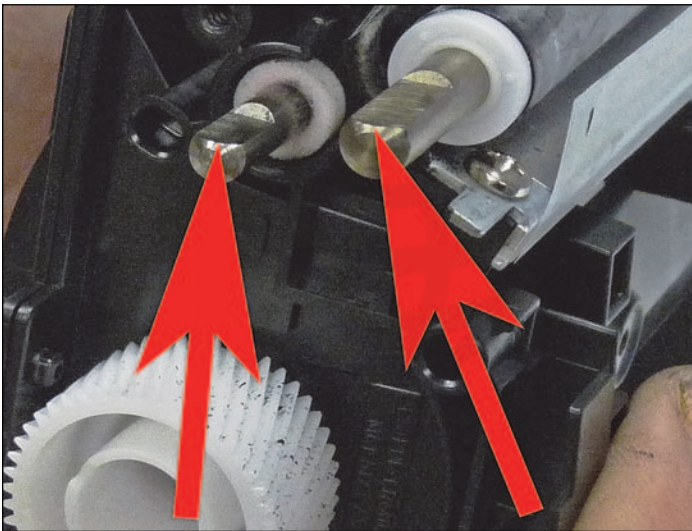

35. Set the developer roller shaft and feed roller shafts as shown (flat side up).

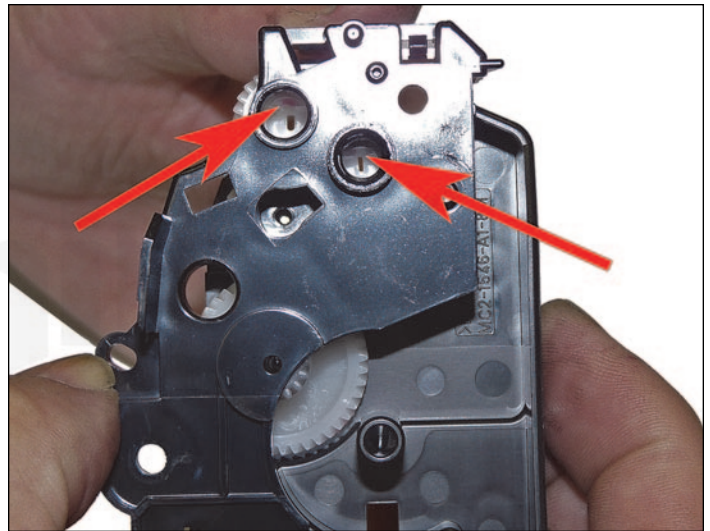

36. Set the gears inside the end cap, so that the two drive gears for these shafts have their flat side also on top.

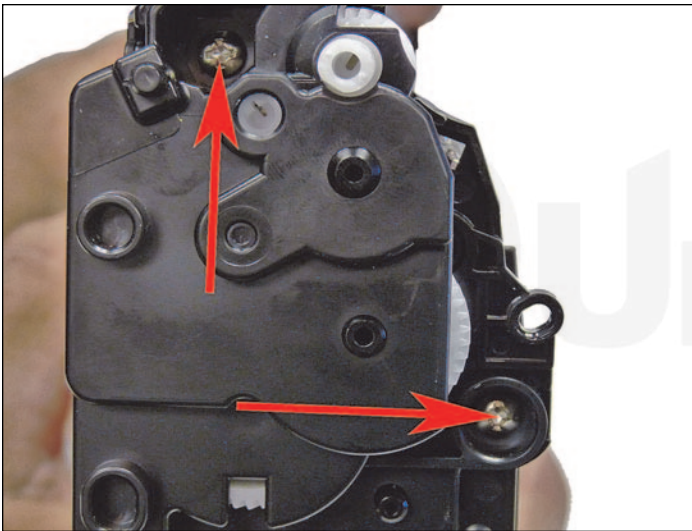

37. Install the gear end cap and two screws. You might have to turn the gears slightly for the end cap to fit in place.

UniNet®



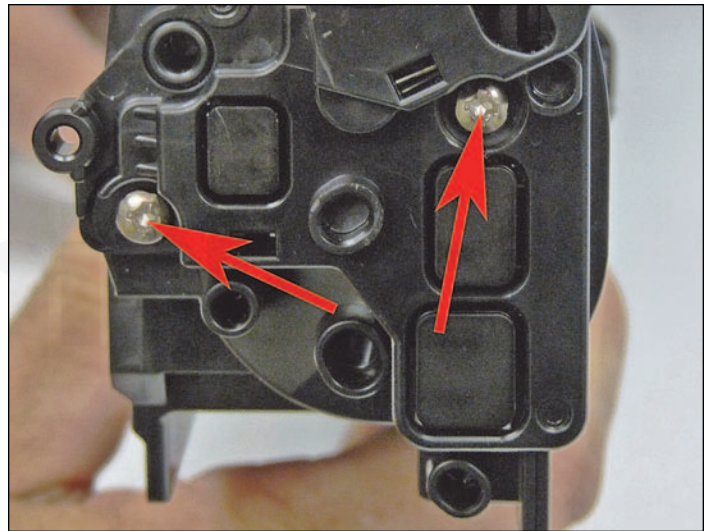
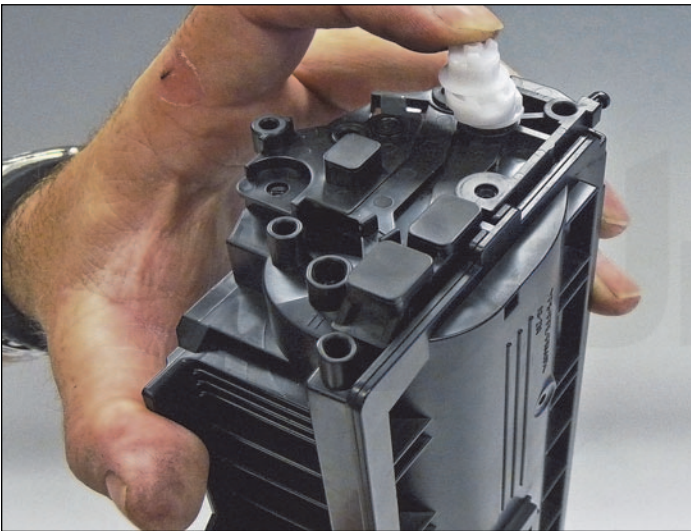

38. Place the triple gear on the developer roller shaft and fit into the spring assembly on the end cap.

Install the end cap screw. Note that there are no metal contacts on this end cap, as you would normally see.

The contacts are there, but are now made of conductive plastic.

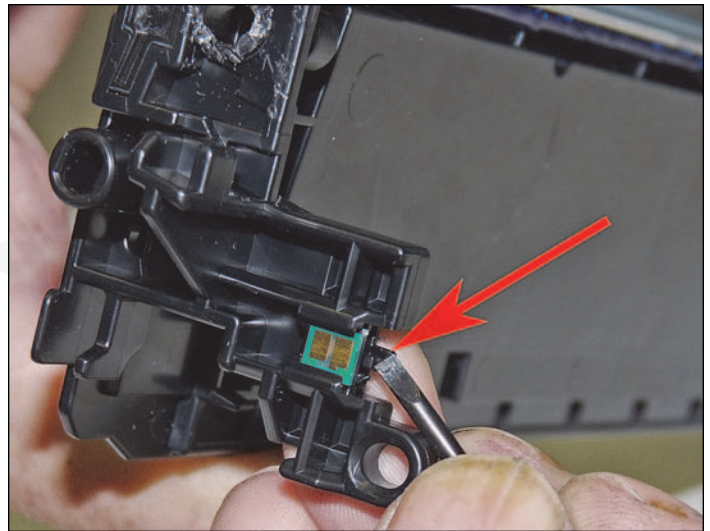

39. On the waste chamber, remove the chip by cutting the plastic off the edges of both sides of the chip and prying the locking tab back slightly.

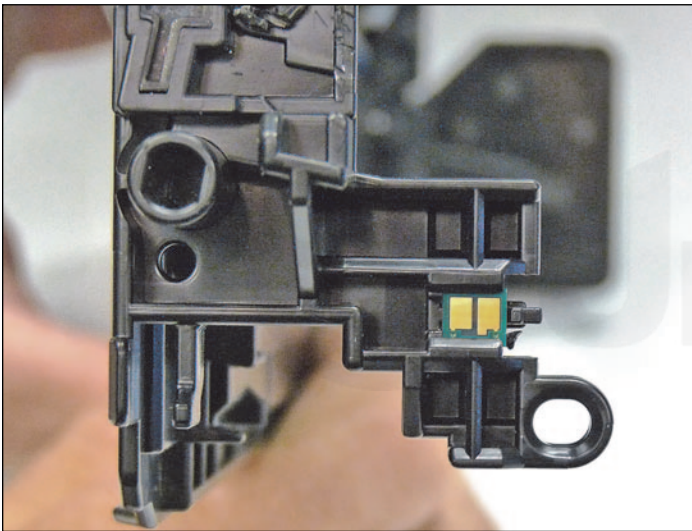

40. Remove and replace the chip. Make sure you have the correct color chip and the correct series!

41. If the new replacement chip is loose in the slot. Close off the top edges with small amounts of hot glue.

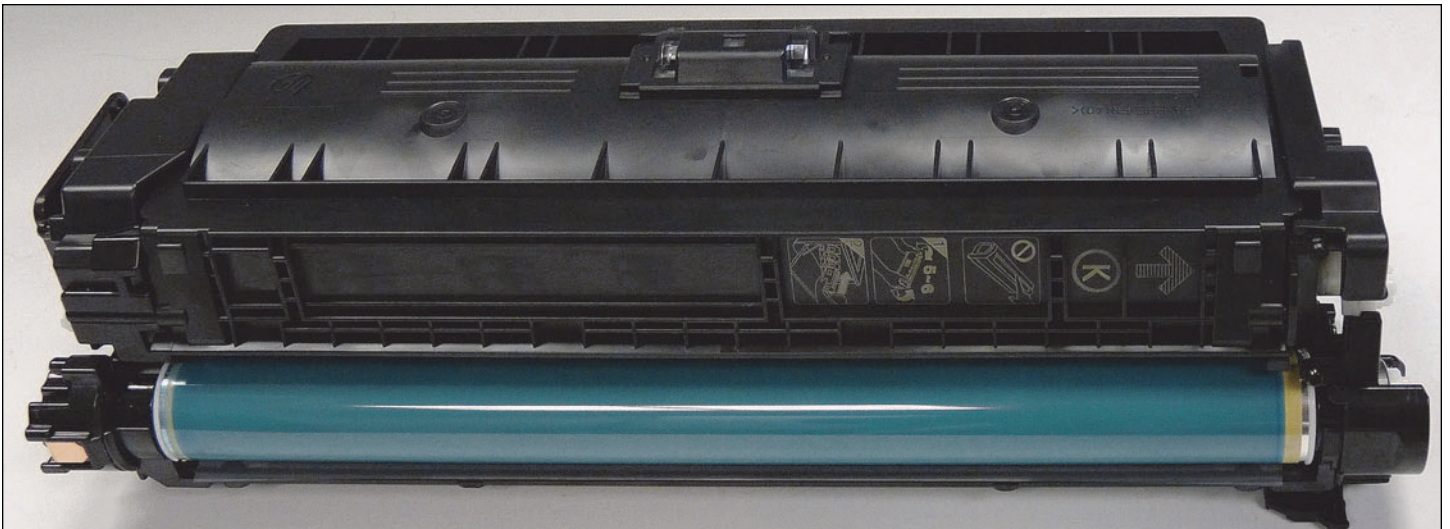

42. Place the two halves together.



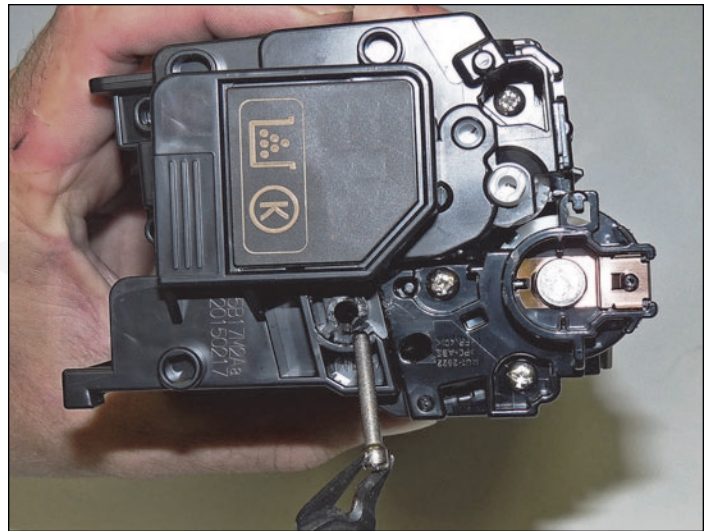
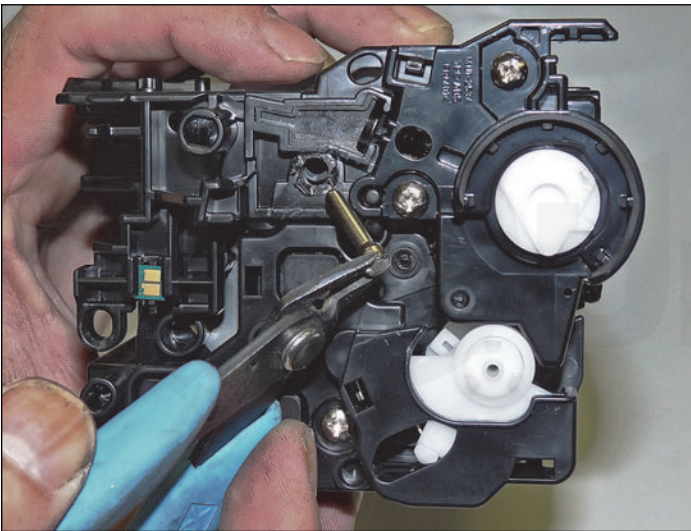

43. Install the two pins, large pin to the label or gear side of the cartridge.

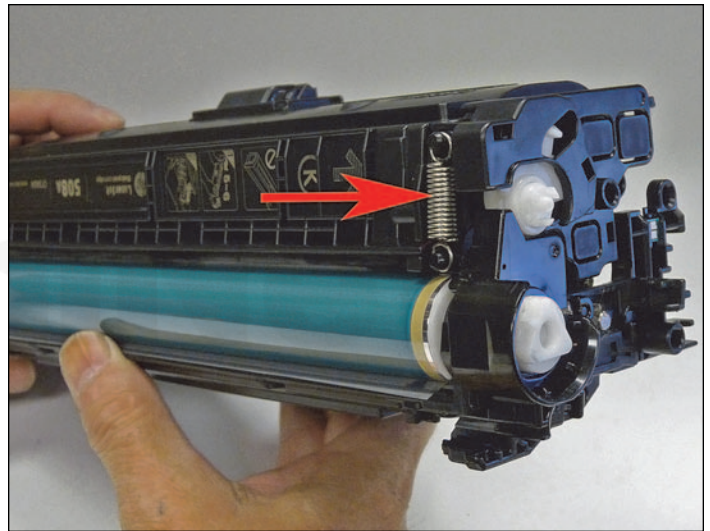
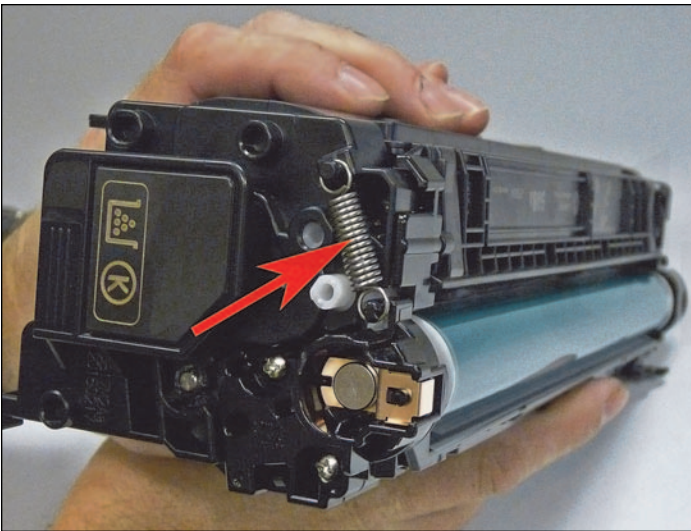

44. Install the two springs.



45. Install the drum cover. This cover is important in that it separates the drum and developer roller helping to prevent a flat spot on the developer roller.

#### REPETITIVE DEFECT CHART

Distance	Our description
27.0mm	Primary Charge Roller
32.0mm	Developer Roller Sleeve
42.0mm	Registration Roller
50.0mm	Secondary Transfer Unit
58.0mm	Fuser Sleeve
75.0mm	OPC Drum
69.0mm	Fuser Pressure Roller