

HP® CP2020 • 2025

TONER CARTRIDGE REMANUFACTURING INSTRUCTIONS



HP CP2025 TONER CARTRIDGE

REMANUFACTURING THE HP CP2020/2025 BLACK & COLOR TONER CARTRIDGES

By Mike Josiah and the Technical Staff at UniNet

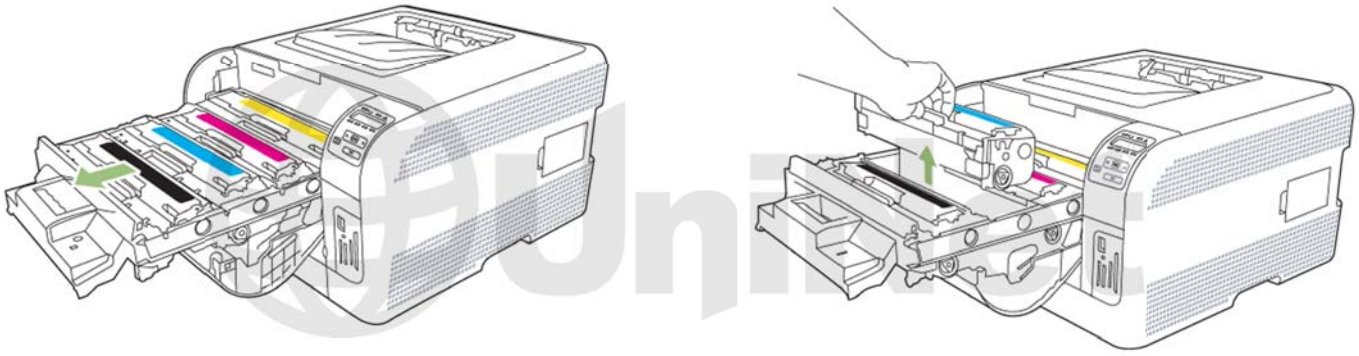

First released in April 2008, the CP 2025 series of color laser printers are based on a 21ppm black and color, 600 dpi engine (3600 dpi with RET). The 2025 cartridges are an all in one type cartridge that consists of the toner supply, drum, and waste chamber. Like the CP1215 these machines use an in-line, or single pass system. Also like the CP1215 all four cartridges are stacked in line front to back instead of on top of each other as in older HP single pass machines.

Because of this new machine layout, we will take a moment and run through the printer theory before we get started. These cartridges are basically a rectangular shaped cartridge that comes with a toner seal and a snap-on drum cover across the bottom to protect the drum.



New machines ship with starter cartridges rated for 1,200 pages so users will run out of toner fairly quickly.

These cartridges also use chips that should be replaced each cycle for the cartridges to have full functionality.

PRINTERS BASED ON THE CP2025 ENGINE

- HP Color LaserJet CP2025n
- HP Color LaserJet CP2025dn
- HP Color LaserJet CP2025x
- HP Color LaserJet CP2020 (Asia only)

CARTRIDGES USED IN THESE MACHINES

CB530A (Black)	3,500 pages	\$115.99 List*
CB531A (Cyan)	2,800 pages	\$114.99 List*
CB533A (Magenta)	2,800 pages	\$114.99 List*
CB532A (Yellow)	2,800 pages	\$114.99 List*

*List pricing, in U.S. American dollars, current as of December 2008.

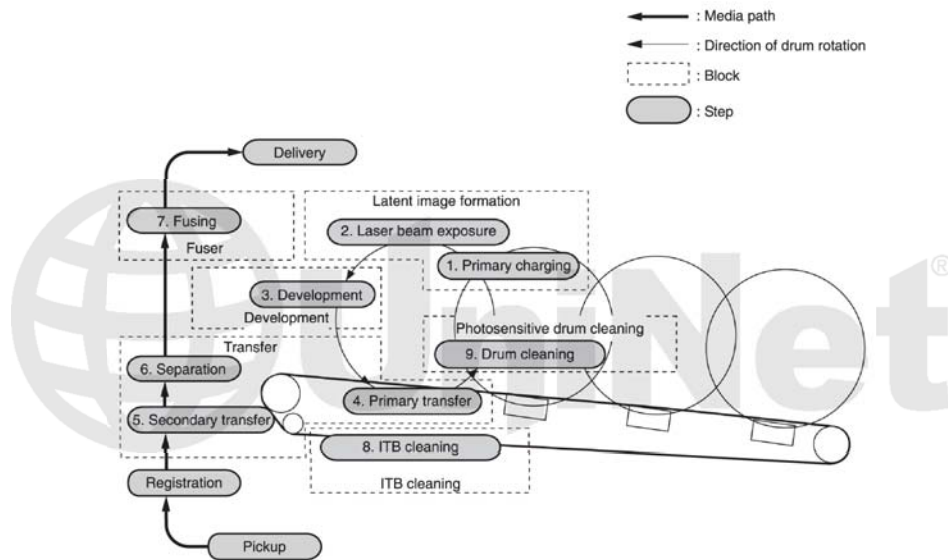
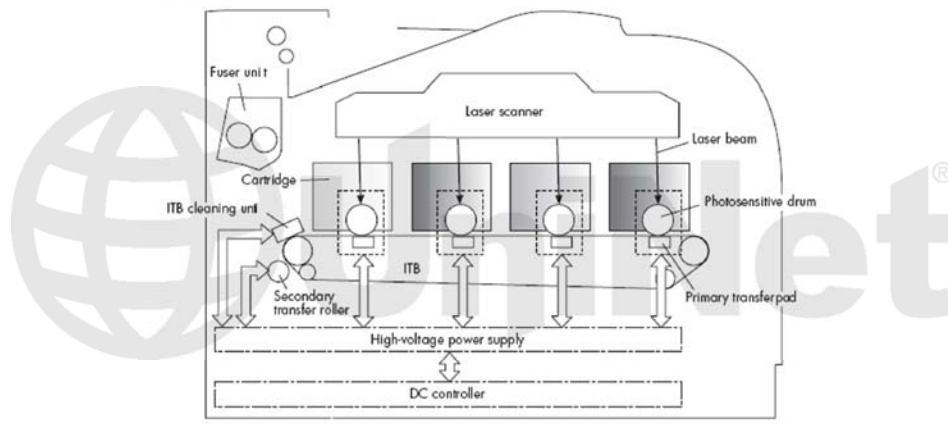

HP CP2025 COLOR PRINTING THEORY

The color toner cartridge printing process happens in a series of stages or steps. For the purpose of this article, we will call them stages. Shown above is the basic layout of the cartridges and how they relate to one-another and the printer. Note that while this is still a single pass system, the layout is completely different from any previous Canon/HP machines. Shown above is a diagram of the complete image formation process.

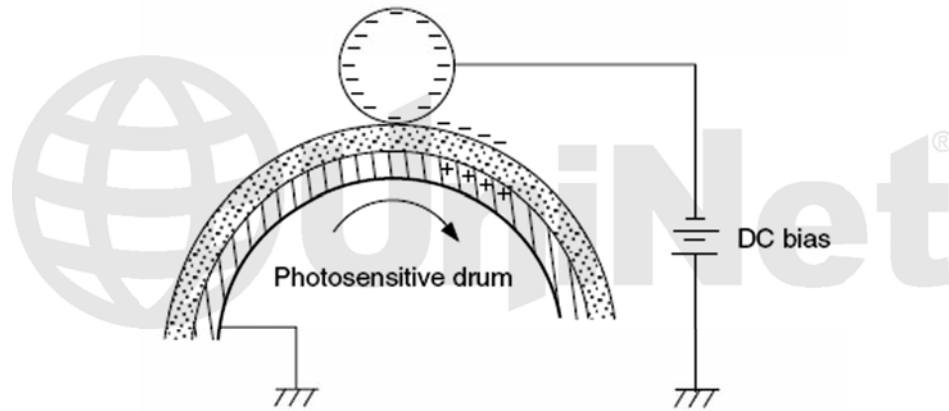

In the **first stage**, the Primary Charge Roller (PCR) places a uniform negative DC voltage on the OPC drum surface.

The amount of the negative DC voltage placed on the drum is controlled by the printer's intensity setting.

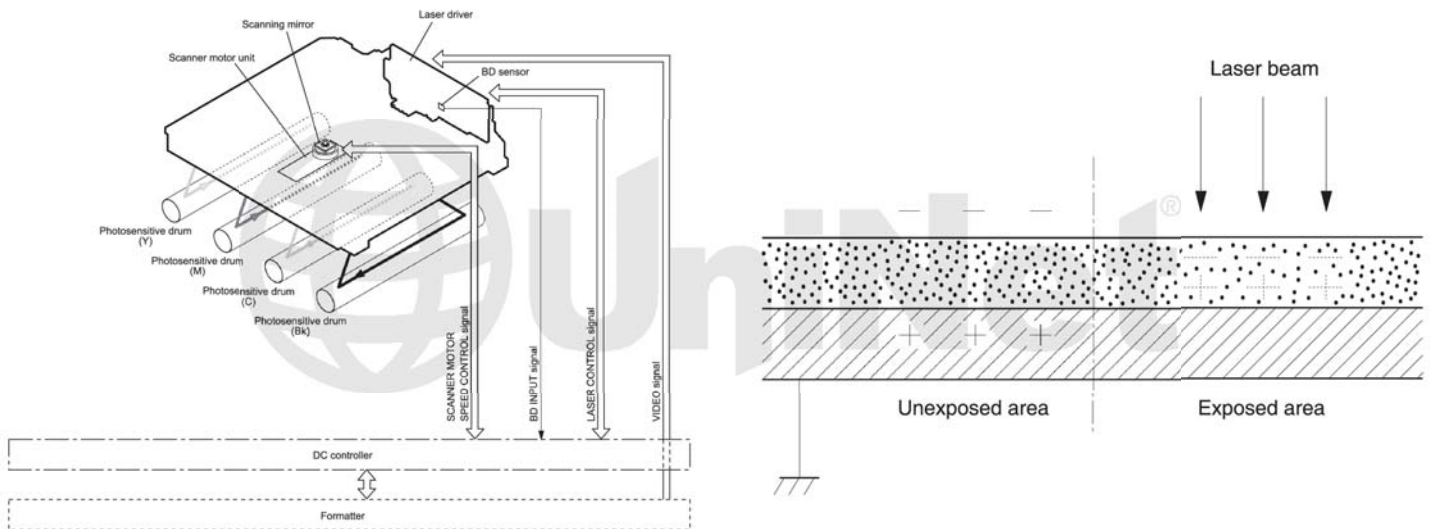

In the **second stage**, the laser beam is fired onto a rotating mirror (called the scanner). As the mirror rotates, the beam is reflected into a set of focusing lenses. The beam then strikes the drums surface, reducing the negative charge and leaving a latent electrostatic image on the drum. The areas where the laser did not strike the drum will retain the higher negative charge. Technology has advanced tremendously in these machines as there is one laser/scanner unit for all four colors. The laser/scanner unit contains one scanning motor and mirror with four separate lasers.

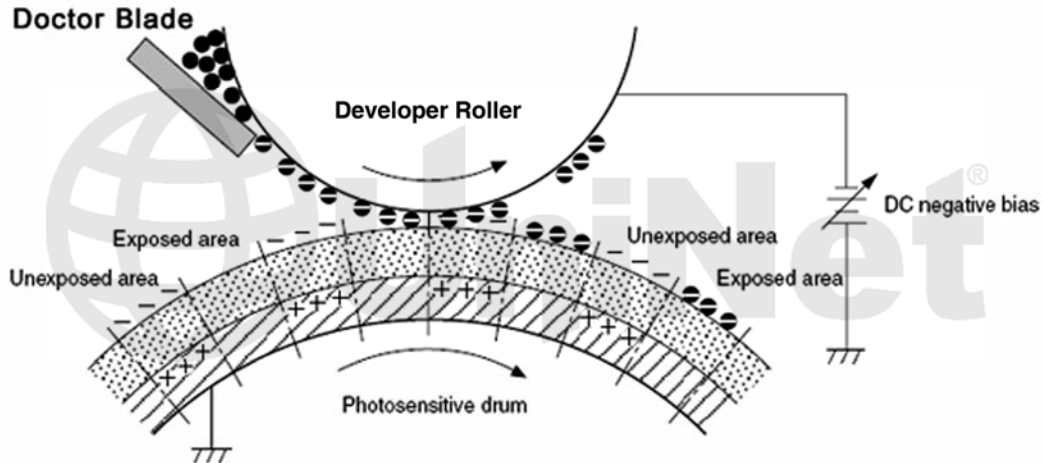

The **third or developing stage** is where the toner is developed on the drum by the developing section (or supply chamber), which contains the toner particles. The development stage is actually made up of two steps: toner charging, and the actual development. In the toner charging stage, the toner stirring blade turns inside the hopper. As it turns, friction causes a negative potential to develop on the toner. In addition, a foam feed roller brings the toner to the developer roller and also places a negative charge on the toner. These two charges help ensure a uniform charge on the toner. Once the toner is properly charged, the toner will coat the developer roller. The toner is also held onto and attracted to the developer roller by another negative DC bias voltage. This voltage is controlled by the printer's intensity setting and causes either more or less toner to be attracted by the developer roller. This in turn will either increase or decrease the print density. The amount of toner on the developer roller is controlled by the doctor blade, which uses pressure to keep the amount of toner on the roller constant. As the laser exposed areas of the OPC Drum approach the developer roller, the toner particles are attracted to the drum's surface due to the opposite voltage potentials of the toner, and laser exposed areas of the OPC drum.

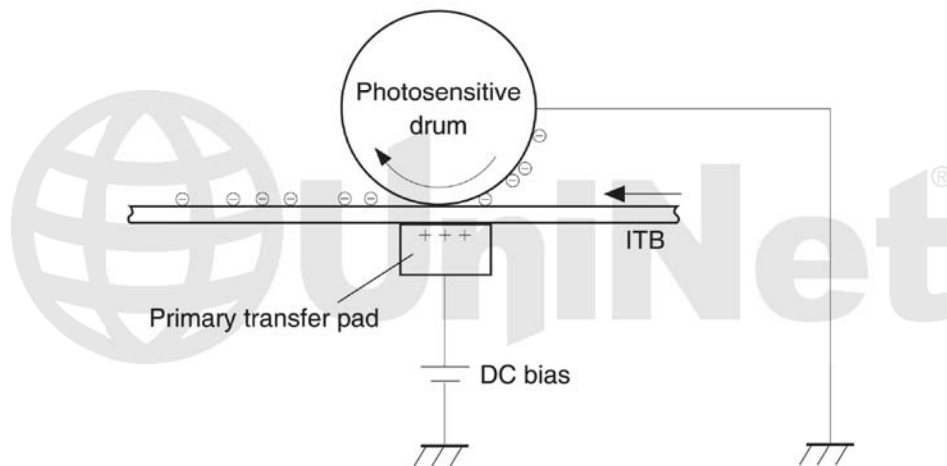

The **fourth stage** is the **transfer stage**. This is where there are some large differences from monochrome printers and also from other color lasers. In the Primary transfer stage the transfer pad (Not a roller in this case) which is located directly opposite each OPC drum, places a positive DC bias charge on the back of the ITB or Image Transfer Belt. Each toner cartridge has a separate transfer charge pad. The image is transferred from the drum directly to the ITB. This process is repeated for each color cartridge in the following order: Yellow, Magenta, Cyan, and Black. At the same time, the paper is moving between the Secondary Transfer Roller and the ITB. As the ITB passes the Secondary Transfer Roller, the positive charge is picked up, and draws the negatively charged toner off the Belt and onto the paper.

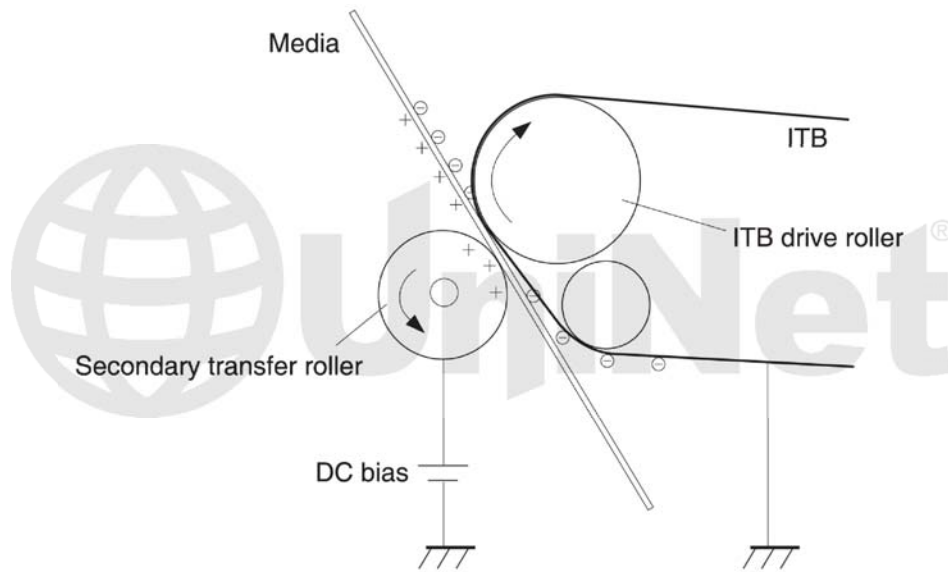

The paper separates from the ITB belt as the belt reaches the top of its path and turns back down to start the process again. The static charge on the back of the paper is decreased with static charge eliminator. This helps stabilize the paper feed and also prevents toner flares (spots) under low temperature and low humidity conditions.

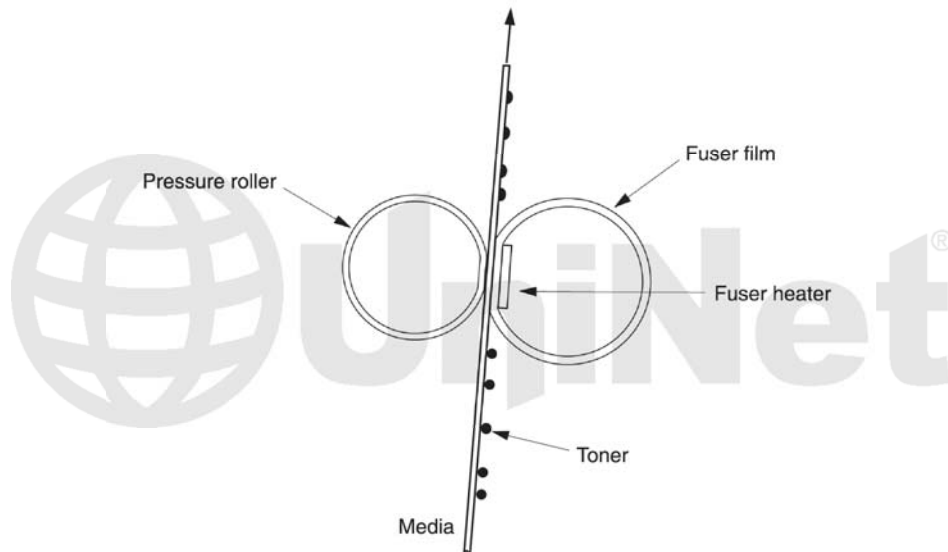

In the **fifth stage**, the image is then fused onto the paper by the fuser assembly. The fuser assembly is comprised of the upper heating assembly and lower pressure roller. The lower pressure roller presses the page up into the upper heating assembly which then melts the toner into the paper. This heating assembly consists of a flexible sleeve with a ceramic heating coil inside. This type of fuser affords “instant on” fusing with little to no wait time, and low power consumption.

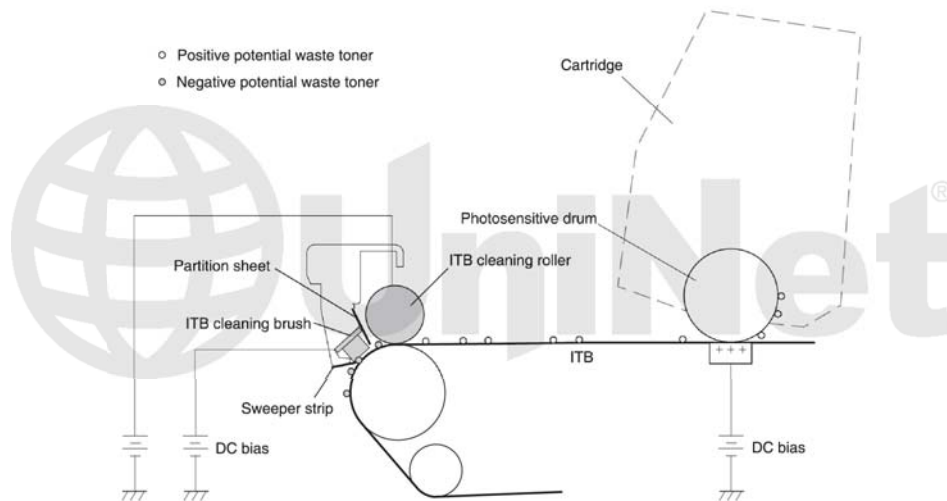

ITB CLEANING

The ITB is cleaned by both the ITB cleaning Roller, and the ITB Cleaning brush. Both the roller and brush have a DC positive bias placed on them which in turn places a positive DC Bias on the residual toner. The Residual toner is then picked up by the OPC drum (Because of the positive bias) and then cleaned off the drum by the wiper blade.

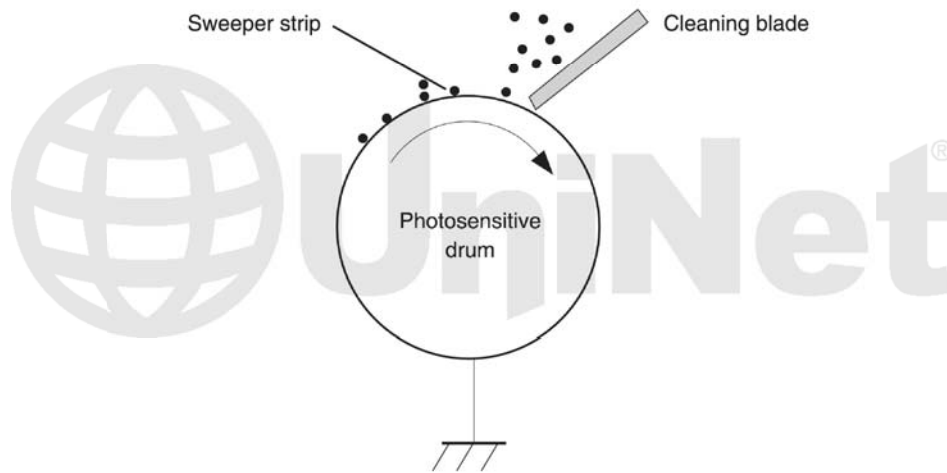

OPC DRUM CLEANING

The drum is cleaned after the image is transferred to the paper by the wiper blade. This part is fairly standard; the wiper blade scrapes the toner off the drum and the recovery blade guides it into the waste chamber.

PRINTER CALIBRATION

At the start of all this is the cartridge detection process, toner level detection, and then the calibration cycle. The printer will calibrate itself whenever the printer is turned on (within 15 minutes), when a new toner cartridge is installed and after 48 hours of run time. Calibration consists of a solid block and halftone of each color being printed to the ITB. As the printed areas get to the top of the belt, a sensor will detect them, measure the density, and adjust the printer accordingly. All of the calibration time settings are user controllable.

Taking test prints, cartridge troubleshooting as well as minor printer troubleshooting will be covered at the end of this article.

REQUIRED TOOLS

1. Toner approved vacuum
2. A small screwdriver (common style)
3. A Phillips head screwdriver
4. Needle nose pliers

SUPPLIES REQUIRED

1. Dedicated color toner for use in HP CP2025
2. New replacement chip
3. New long life drum for use in HP CP2025
4. New wiper blade
5. New toner feed roller (optional)
6. New PCR (optional)
7. New doctor blade (optional)
8. Drum cover
9. Lint-free cloths
10. Conductive grease

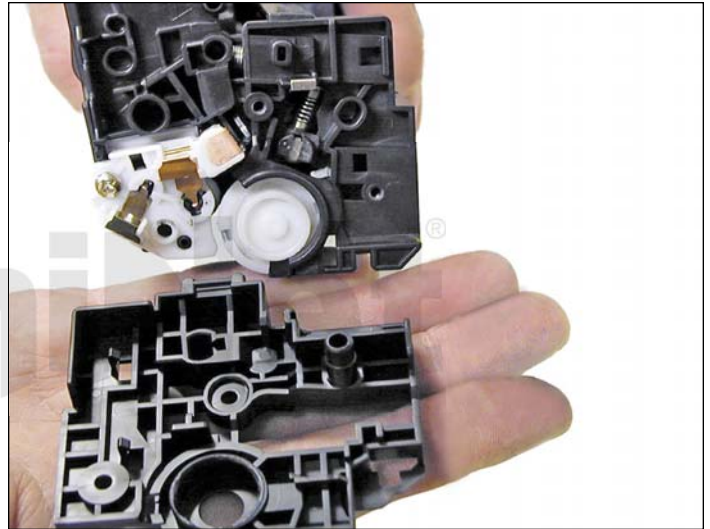
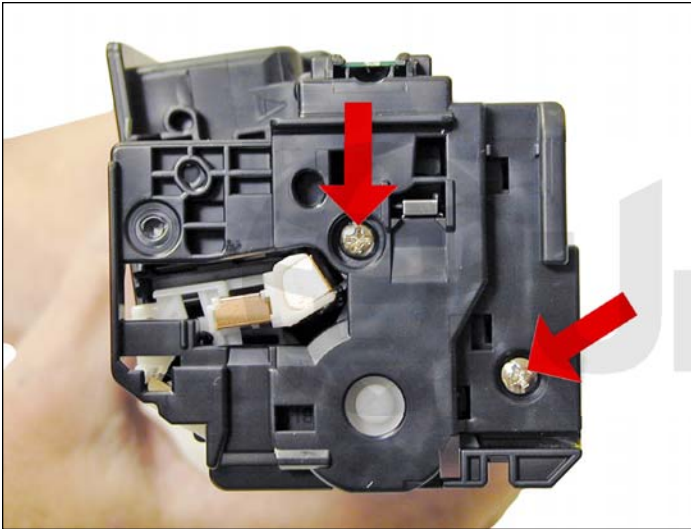

1. With the label on top and facing you, remove the two screws from the left side end cap.

Remove the end cap.

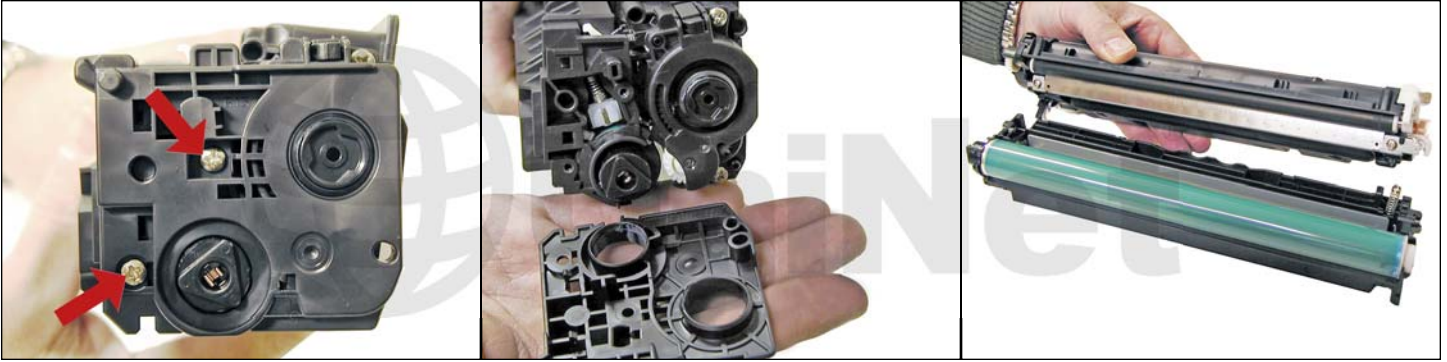

2. On the right side, remove the two screws and end cap.

Be careful. The two halves will start to separate and the drum will come loose.



3. Flip the waste chamber upside down and remove the drum.



4. Remove the PCR.

Clean with your preferred PCR cleaner and place aside.

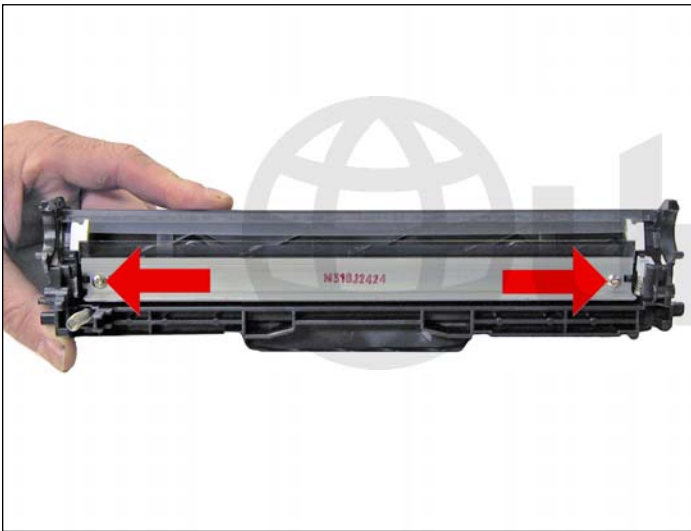

5. Remove the two screws and wiper blade.

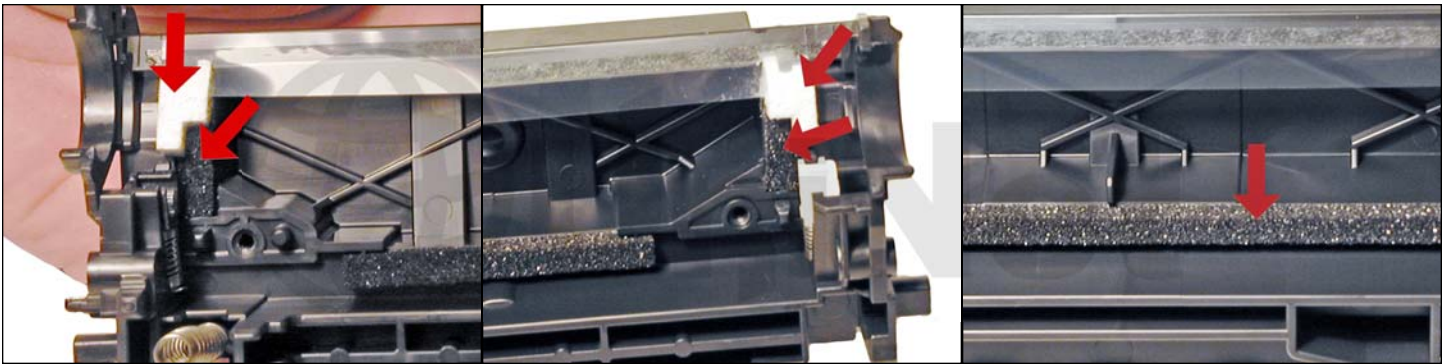

6. Clean out all the waste toner from the chamber.

Make sure all the wiper blade seals are clean.



7. Coat the new wiper blade with your preferred lubricant and install. Install the two screws.

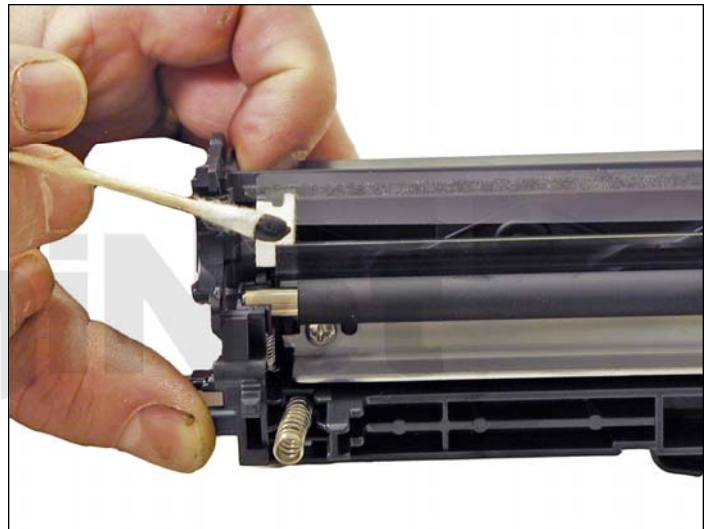

8. Install the cleaned PCR.

Make sure to place a small amount of conductive grease on the black PCR holder.

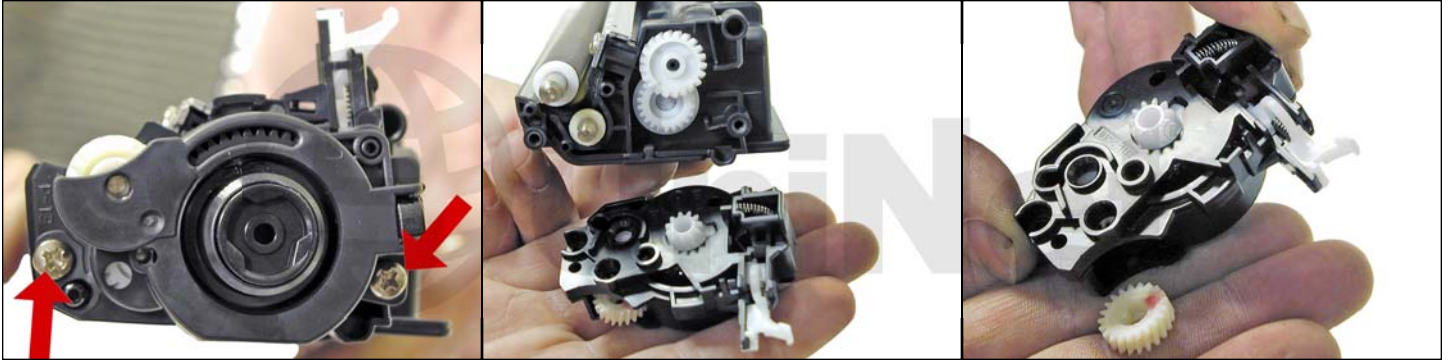

9. On the supply chamber, remove the two screws from the gear side end cap. Lift up on the tab as shown and carefully work the end cap off the hopper. The end cap contains a set of gears, and the drive gear for the developer roller will come loose. Be careful not to lose the gear. Also on this end cap is a spring loaded arm assembly. This arm, we believe, locks the cartridge in place once the tray is inserted and the cover closed.

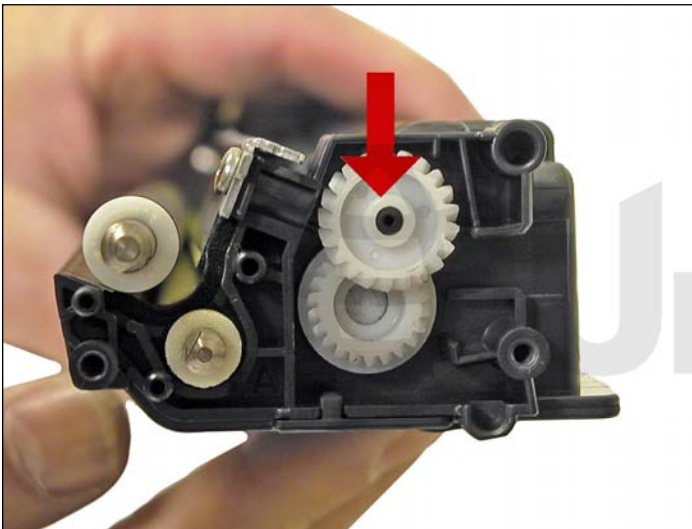

10. Remove the idle gear as shown. Leave the other gear in place as it will not come off, and is very difficult to match back up with the toner auger shaft inside the hopper.

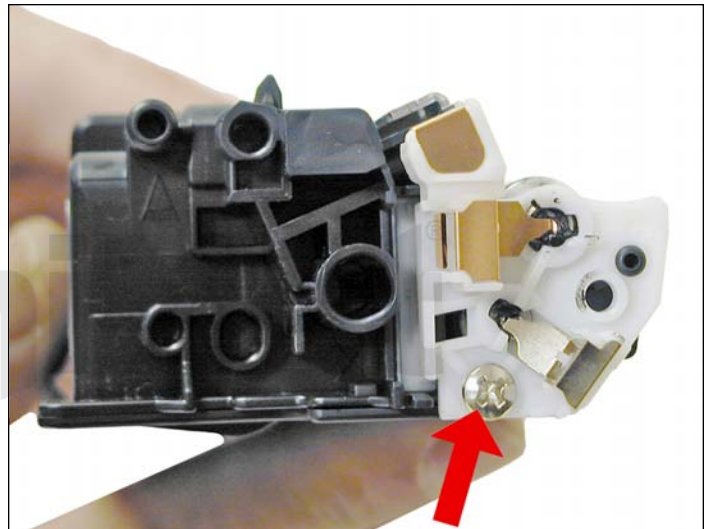

11. Remove the screw on the contact side end cap.

Remove the end cap.



12. Slide the developer roller over and remove.

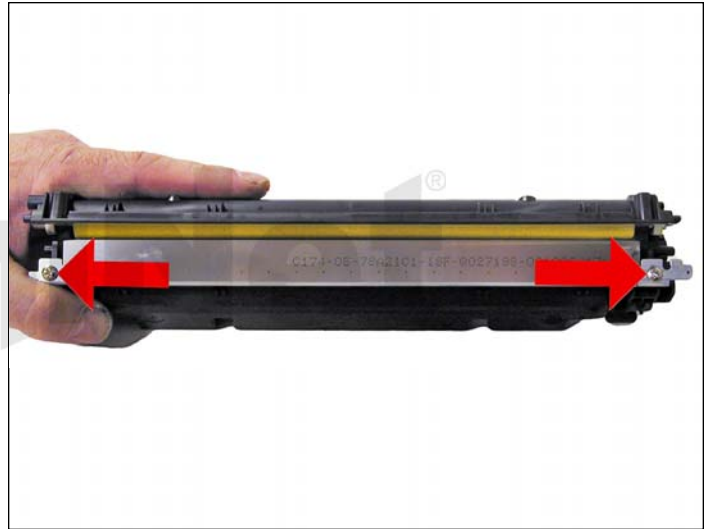

13. Remove the two screws and doctor blade.



14. At this point, while tight, you can clean and fill the hopper with appropriate color toner for use in HP CP2025

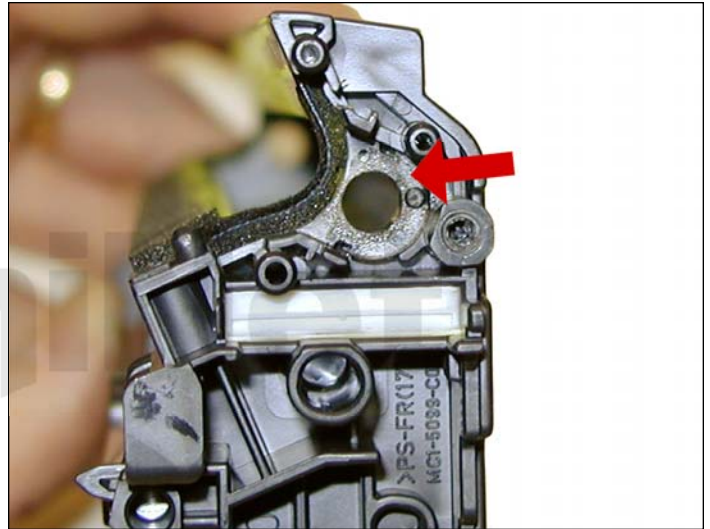

NOTE: HP/Canon created a bit of a block for us here. The clear bushing located on the right side of the hopper (shown above) is glued in. The opposite side bushing is integral to the hopper.

If you wish to install a seal, change the feed roller, or just have better access to the hopper, the feed roller must be pulled over to one side compressing the foam.



First, remove the two white felt seals.

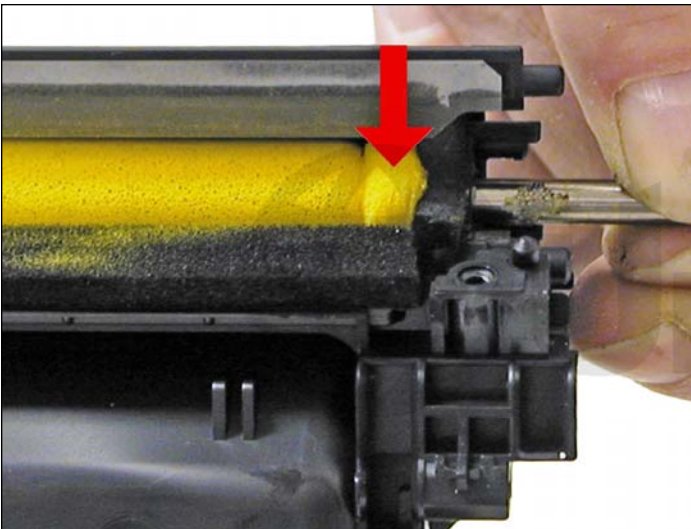

At this point we do not know if this will damage the roller or affect the printing at all.

So far in our tests it has not, but it's too early to say for sure.

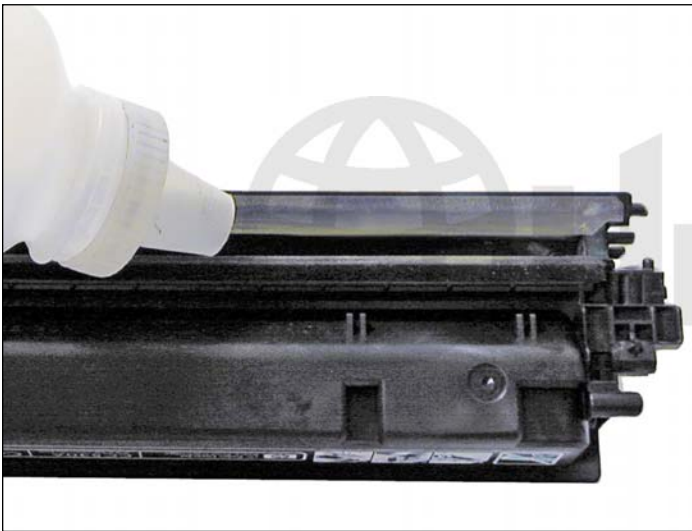

15. If you have not already done so, fill the hopper with color toner for use in HP CP2025 and install the feed roller.



16. Install the two white felt seals on the feed roller shaft.

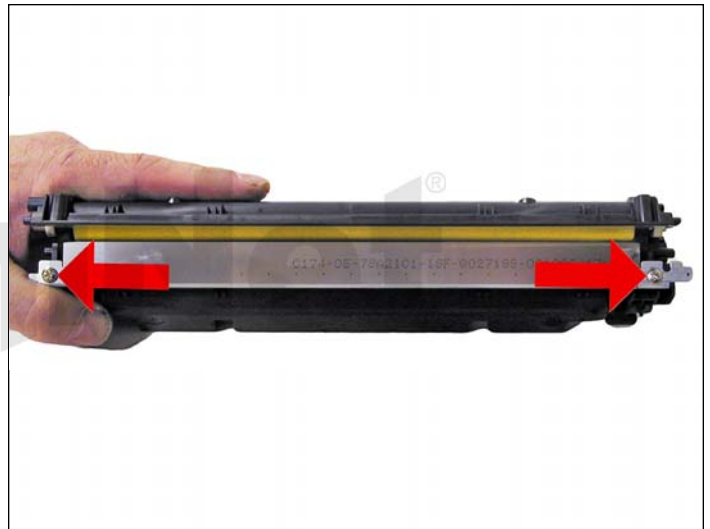

17. Clean the doctor blade foam seal.

Install the doctor blade and two screws.

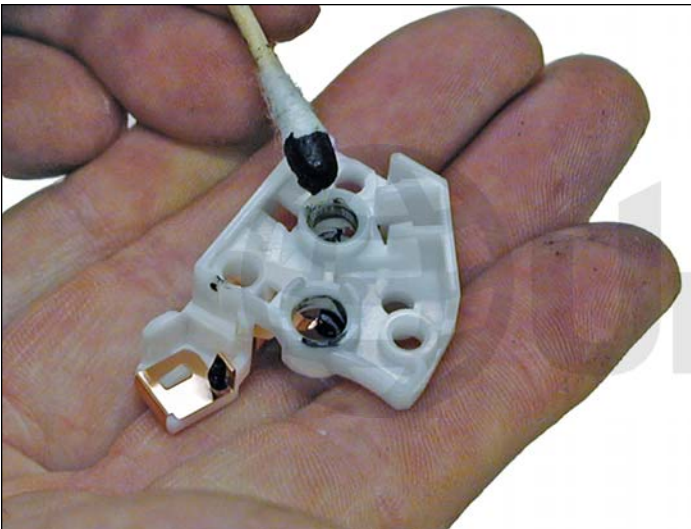

18. Clean the contact on the contact end cap with a cotton swab and alcohol. Replace the conductive grease with fresh grease. Remember, more is not better with this grease.

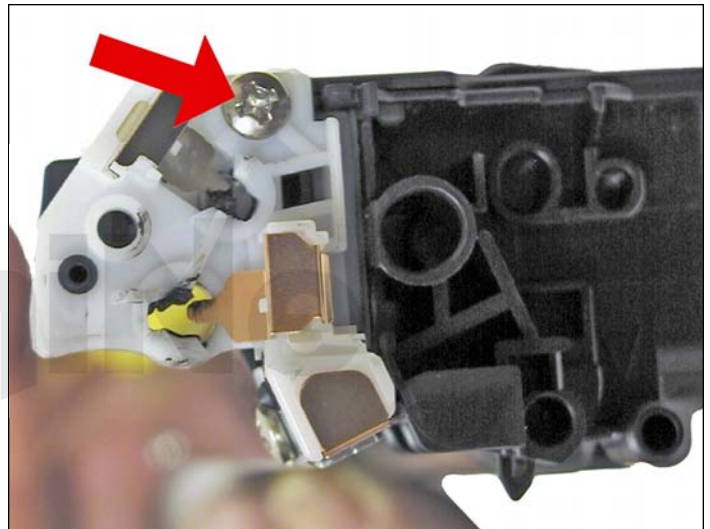

19. Replace the contact end cap and screw.



20. Install the developer roller.



21. Replace the idle gear as shown.

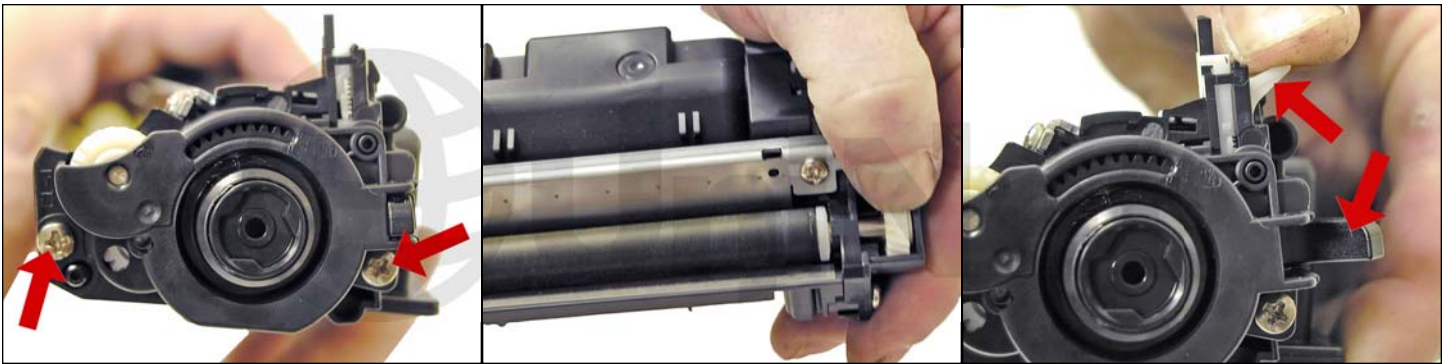

22. Install the gear end cap and screws.

Turn the developer roller so it mates properly with the drive gear.

Make sure the spring arm works.



23. Coat the drum with you preferred lubricant and install the drum in the waste hopper.

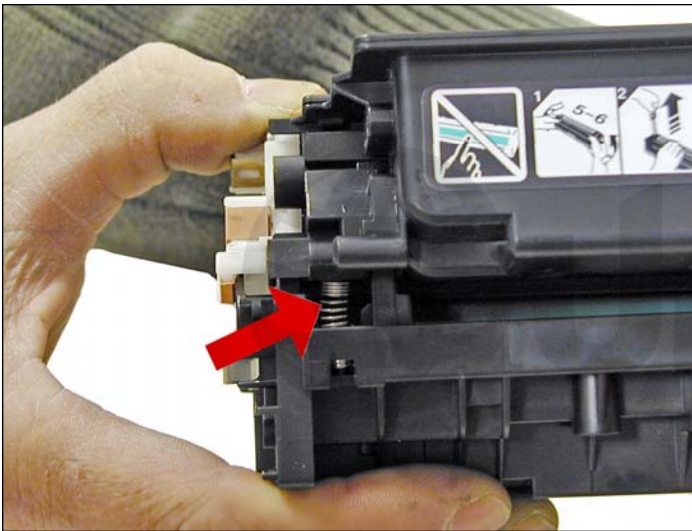

24. Hold the two halves together.

Align the spring on one side and the spring loaded arm on the other.

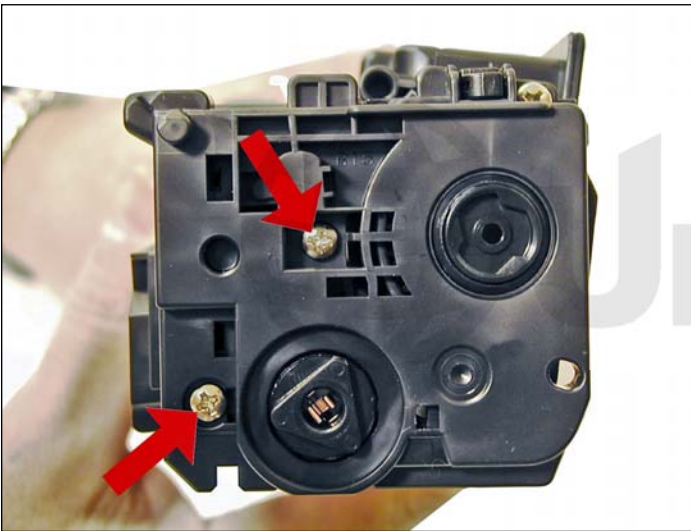

25. Install the outer gear side and cap and two screws.

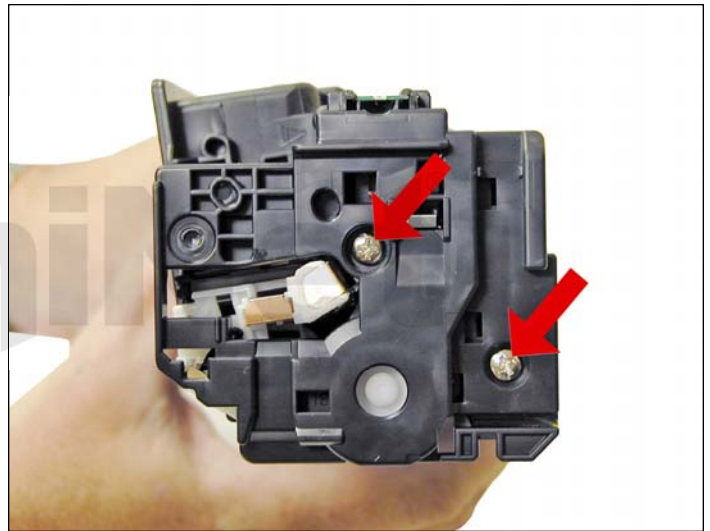

26. Install the remaining outer end cap on the contact side of the cartridge and two screws.

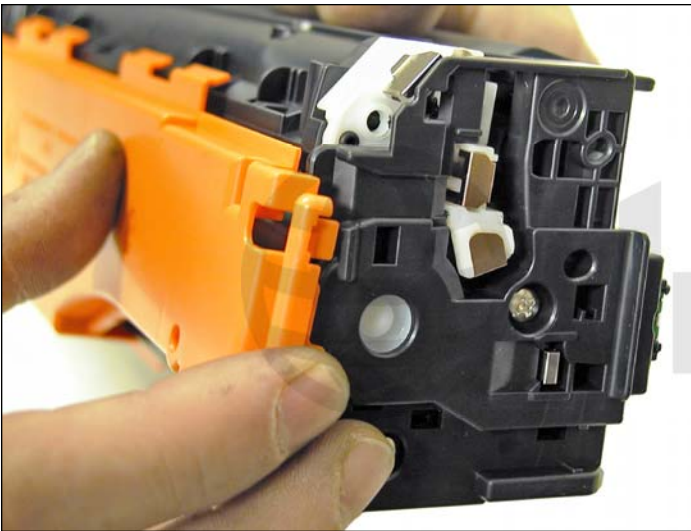

27. Install the drum cover on to the cartridge.

Spread the two halves apart slightly so it fits properly.



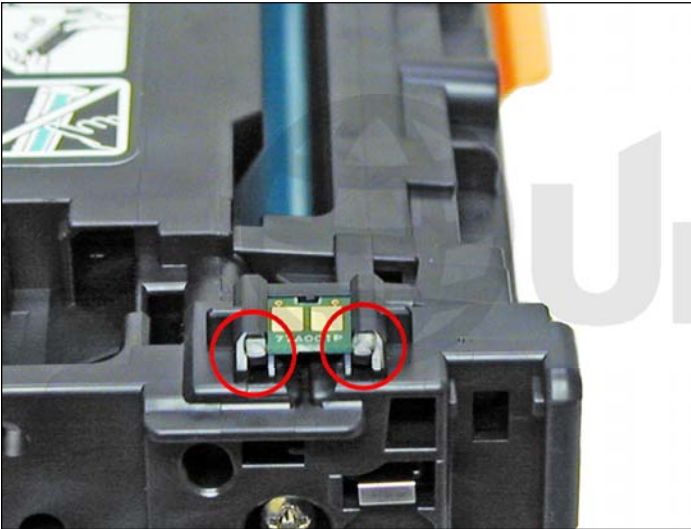

28. Remove the chip by cutting the plastic off the edges of both side of the chip.

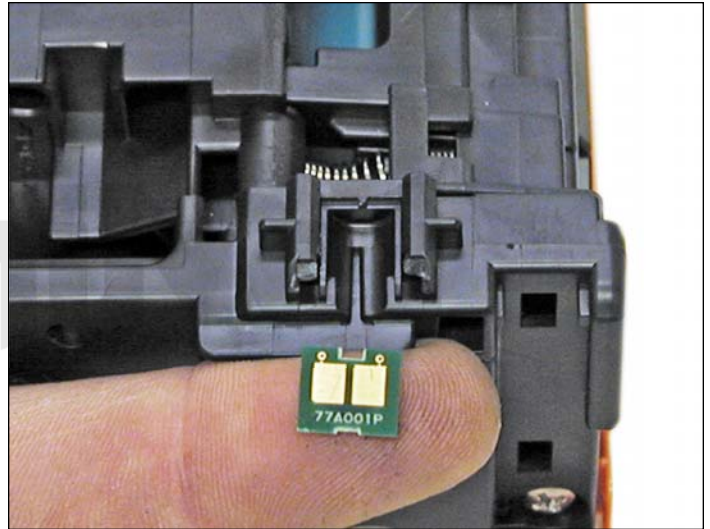

29. Remove and replace the chip. If the new replacement chip is loose in the slot. Close off the top edges with small amounts of hot glue.

TAKING TEST PRINTS

1. Press OK to open the menus
2. Press the left or right arrow until REPORTS appears on the display. Press OK.
3. Press the left or right arrow until the report you want is shown. Press OK.
4. There are multiple reports to choose from:
 DEMO PAGE, MENU, CONFIGURATION, SUPPLIES STATUS, FONT, COLOR USAGE, SERVICE and more are available.
5. Press X to exit the menus.

REPETITIVE DEFECT CHART

ITB Drive roller	78.0 mm
OPC Drum	75.0 mm
Fuser Pressure Roller	63.0 mm
Transfer Rollers	58.0 mm
Fuser Sleeve	58.0 mm
Registration Roller	44.0 mm
Primary Charge Roller	38.0 mm
Developer Roller Sleeve	22.0 mm

COMMON PRINTER ERROR MESSAGES

Most of the error messages are in plain English, but some are numeric only. We have listed the more common ones here. Most of the internal errors listed in the service manual just state something like “Internal hardware error.” They are not very helpful.

10.000X	Supply error. Chip cannot be read or cartridge is not properly installed.
10.0000	Black Chip error
10.0001	Cyan Chip error
10.0002	Magenta Chip error
10.0003	Yellow Chip error
10.100X	Supply error. Cartridge/Chip is missing.
10.1000	Black cartridge/Chip missing
10.1001	Cyan cartridge/Chip missing
10.1002	Magenta cartridge/Chip missing
10.1003	Yellow cartridge/chip missing
51.XX	Printer error/Internal Hardware error. This can be caused if a surge protector is being used. HP recommends removing it and plugging directly into the wall.

CALIBRATE NOW

Sometimes the only way to fix print quality issues is to force a calibration:

1. Open the HP Color LaserJet Toolbox
2. Click the DEVICE SETTINGS folder, then click on the PRINT QUALITY page
3. In the area for color calibration, select CALIBRATE NOW.
4. Click APPLY to start the process.

PRINT DENSITY SETTINGS

These functions are only available through the Tool Box.

There are actually multiple sub settings that can be set under density.

As you can see, these settings can get a little intense and complicated:

Contrasts:	Contrast is the range of difference between light (highlight) and dark (shadow) colors. To increase the overall range between light and dark colors, increase the Contrasts setting.
Highlights:	Highlights are colors that are nearly white. To darken highlight colors, increase the Highlights setting. This adjustment does not affect midtone or shadow colors.
Midtones:	Midtones are colors that are halfway between a white and solid density. To darken midtone colors, increase the midtone setting. This adjustment does not affect highlight or shadow colors.
Shadows:	Shadows are colors that are nearly a solid density. To darken shadow colors, increase the shadows setting. This adjustment does not affect highlight or midtone colors.